

# LOHAS

AUSTRALIA

ROOF TILE COLLECTION

## **FRENCH OLD HOLLOW ROOF TILES SPEC GUIDE**

[LOHASAU.COM](http://LOHASAU.COM)

## Old Hollow Rustic

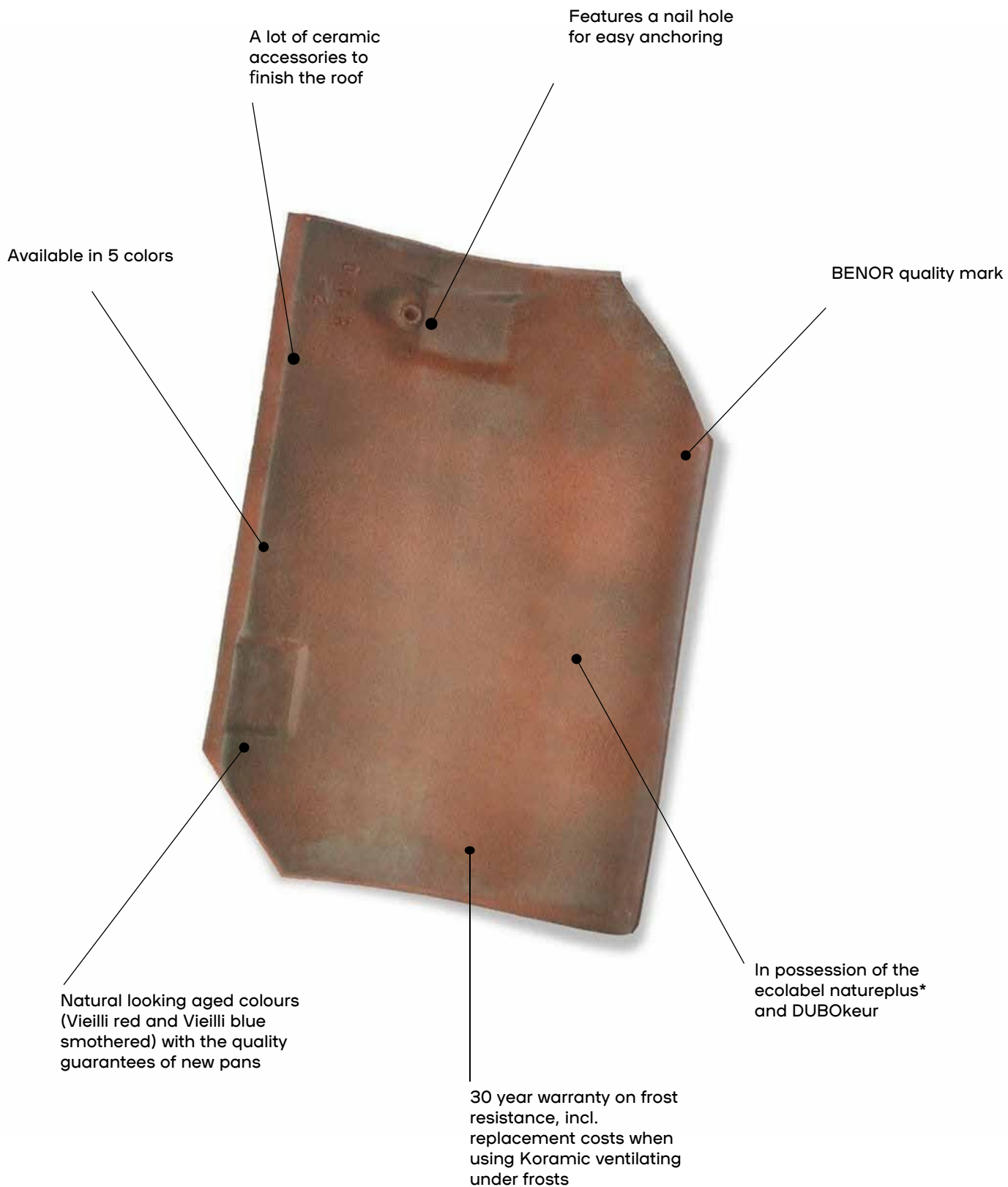

## TECHNICAL INFORMATION

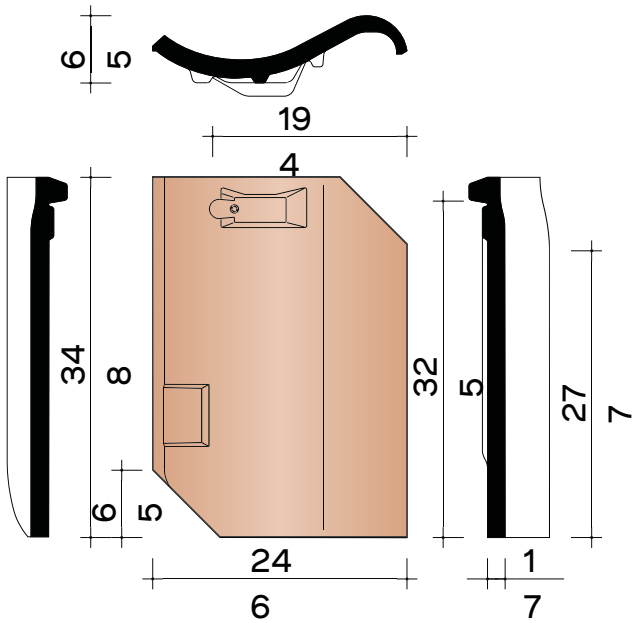

Definition:	Holle padlock
Min. roof slope with shelter - Fleece of Fleece Plus: - Fleece Premium:	25° 15°, subject to the instructions in the brochure Facade and underroof films.
Useful length (bar spacing):	± 277 mm
Useful width:	± 194 mm
Number of pieces/m <sup>2</sup> :	± 18.6
Unit weight:	± 2.3 kg
Weight per m <sup>2</sup> :	± 42.8 kg
Breaking load:	> 1200 N
Impermeability:	≤ 0,5 cm <sup>3</sup> /cm <sup>2</sup> .d
Frost resistance:	Frost resistance
Placement:	Straight

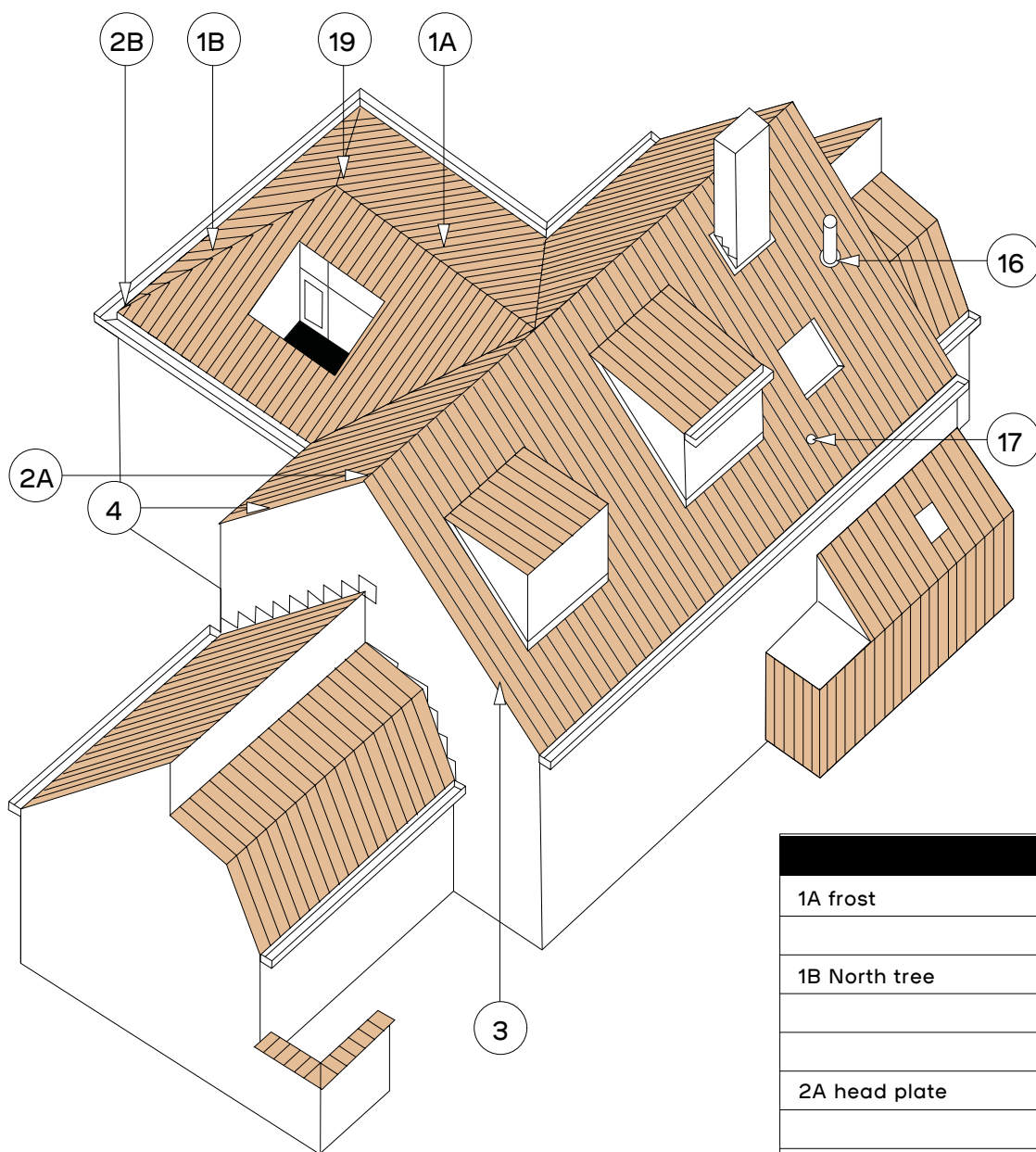

1A frost	1400
	1200
1B North tree	3300
	1200
	3100
2A head plate	1440
	1240
early frost	1230
2B Beginning North Tree	3360
	1260
	3110
3 Left facade tile	7080
Pan with double well	8050
4 Right facade tile	7090
16 Kit cooker + cap	8741
17 Ventilation pan	8640
19 prince hat	5500
	5730
	5740
connecting piece	5290
	5120
	5630
	5640
	5020
	5250

1



2



3





1. Old Hollow Victorian Blue
2. Old Hollow Victorian Blue and Victorian Red
3. Old Hollow Natural Red
4. Old Hollow Braised Blue

**COLOUR RANGE**



Natural Red

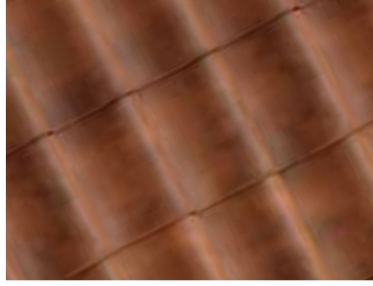

Rustic



Victorian Red

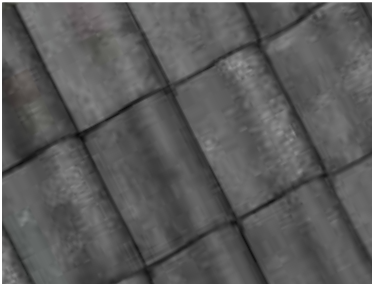

Victorian Braised Blue

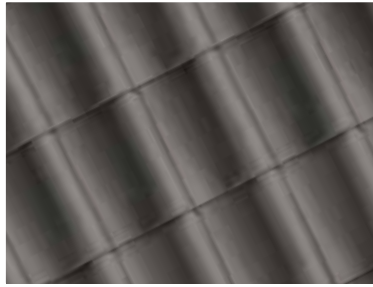

Braised Blue

# TECHNICAL INFORMATION - LAYING PLANS

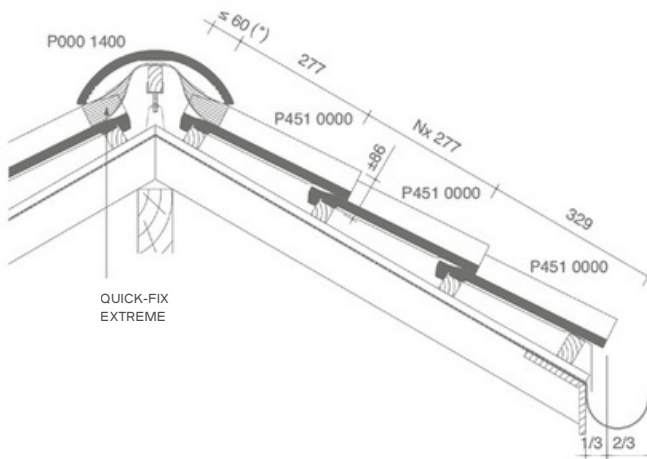

Length-section roof at the height of frost without closure 1400 - quick-fix extreme

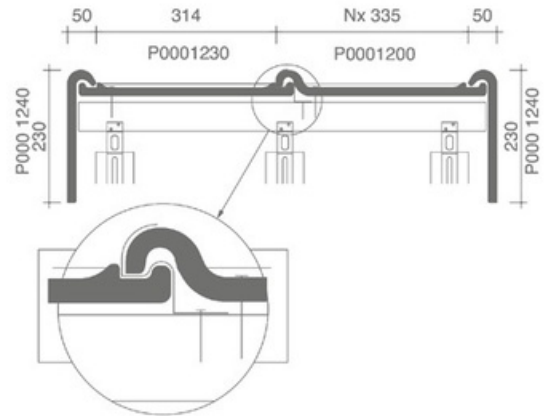

Cross-section roof at frost with closure 1200

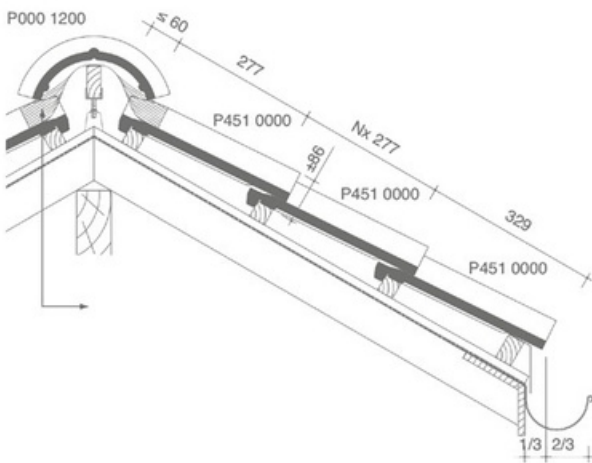

Length-section roof at frost with closure 1200

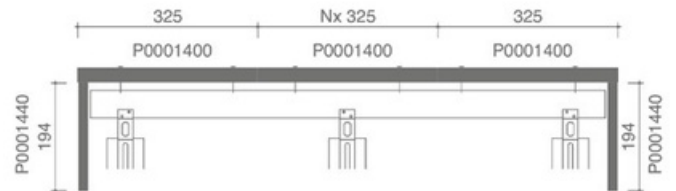

Cross-section roof at the height of frost without closure 1400 - quick-fix extreme

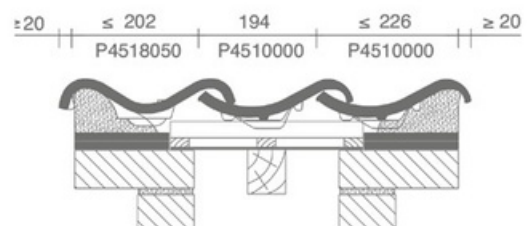

Cross-section roof with double well pan

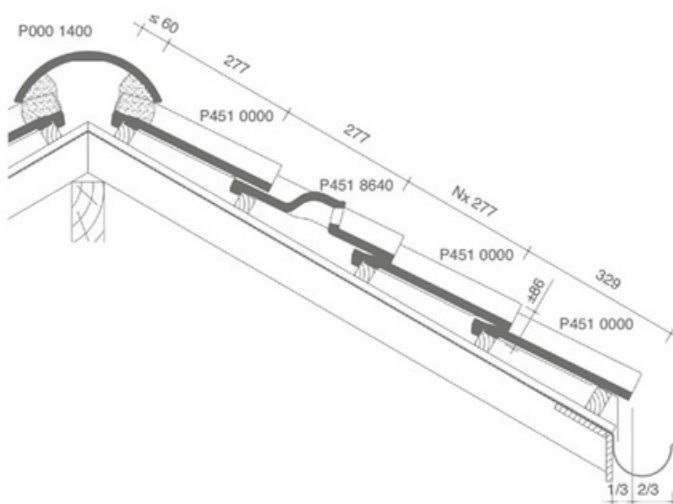

Length-section roof at the height of frost without closure 1400 with ventilation pan-mortarred

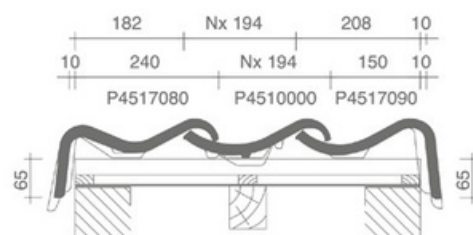

Cross-section roof at pan at the height of facade tile



**TECHNICAL INFORMATION**

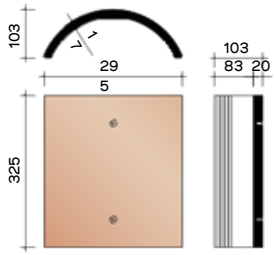

X

P0001400  
3 - 3.1 pieces/Lm  
Semicircular - 225 mm

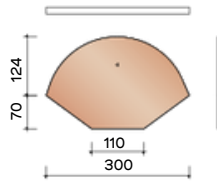

P0001440  
Headplate - 255mm

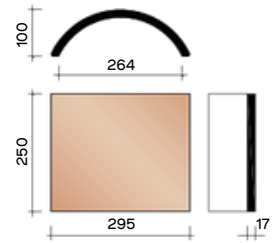

P0000900  
4 pieces/Lm Old boom frost

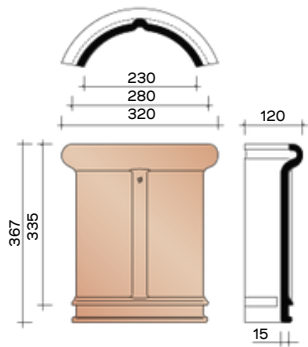

P0001200  
3 pieces/Lm Semicircular  
frost/northern tree - 225 mm

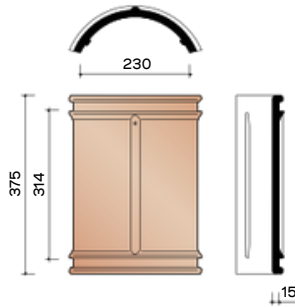

P0001230  
Semicircular initial frost - 230 mm

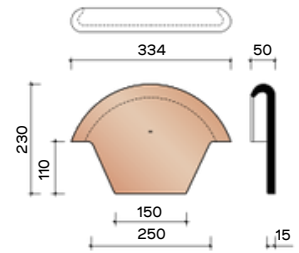

P0001240  
Headplate - 230mm

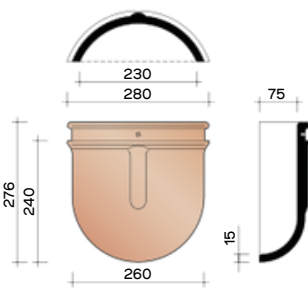

P0001260  
Semicircular North Pole  
- 230 mm

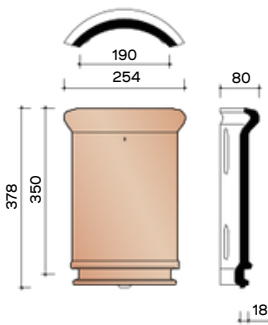

P0003100  
3 pieces/Lm Semicircular  
North Pole - 190 mm

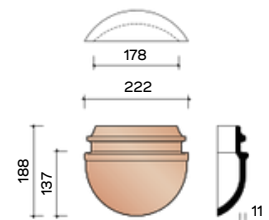

P0003110  
Semicircular North Pole - 190  
mm

X Dry place with Quick-Fix  
Extreme

## TECHNICAL INFORMATION - GABLE TILES

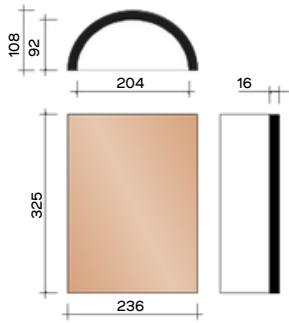

X

P0003300  
3.1 pieces/Lm Semicircular North Pole - 210 mm

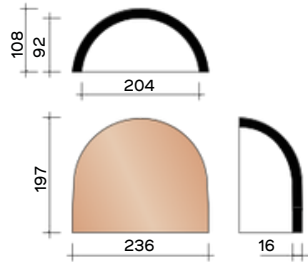

X

P0003360  
Semicircular North Pole - 210 mm

### Quick Fix Extreme

With the Quick-Fix Extreme ventilating under frost you can install frosts without closure, which you normally have to mortar in, dry place.

Done with those annoying mortar splashes that require a lot of cleaning work or cause can give rise to complaints from your client.

The system consists of two parts. On a finely ru ed, micro perforated aluminum roll with acrylic coating, becomes wide non-perforated deck roll fixed in aluminum which protects the micro-perforations against water infiltration.

At the bottom is provided the ventilating under frost with an innovative adhesive strip that also allows on misted and cold pans.

- Colours: red (deck roller is brown) and black.
- Width: 320mm
- Package contents: 1 roll of Quick-Fix Extreme of 5 running meters and 40 stainless steel screws (4.5 x 80 mm) with washer and neoprene ring for fastening the princes (2 screws per frost).

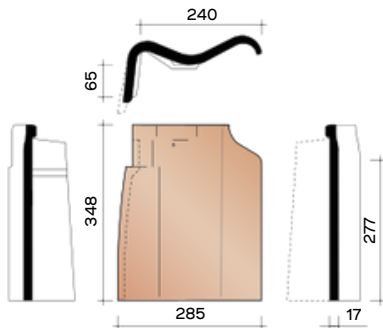

P4517080  
3.6 pieces/Lm Left facade tile

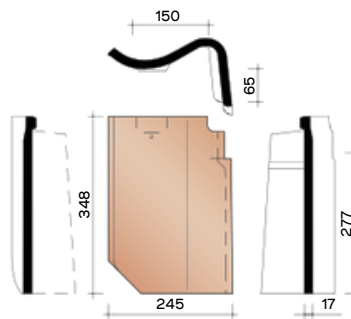

P4517090  
3.6 pieces/Lm Right facade tile

X Dry place with Quick-Fix Extreme

**TECHNICAL INFORMATION - OTHER ACCESSORIES**

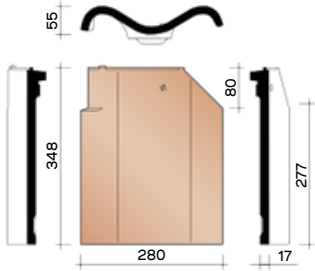

**P4518050**  
3.6 pieces/Lm Double Well Pan

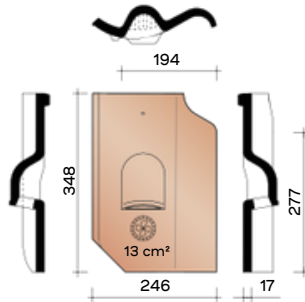

**P4518640**  
Ventilation pan with grid in plastic - 13 cm<sup>2</sup>

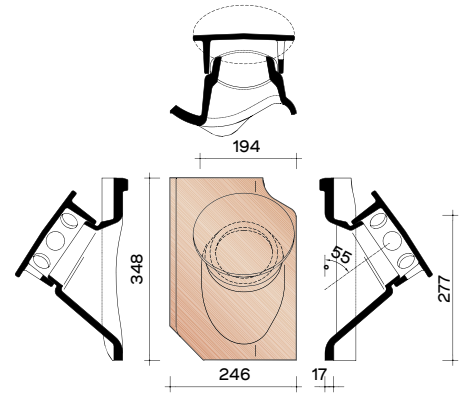

**P4518741**  
Cassette pan kit Ø 100 mm + cap - 95 cm<sup>2</sup> + connection module + reducer piece

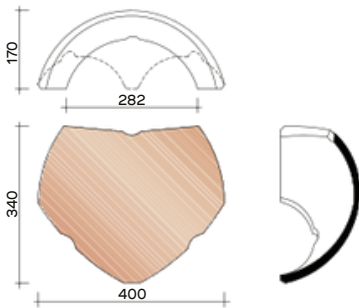

**P0005500**  
Prince's hat between 1 prince 1200 and 2 princes 1200 as a north tree

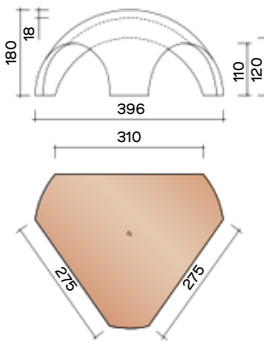

**P0005730**  
Prince's hat between 1 frost 1400 and 2 north trees 3100

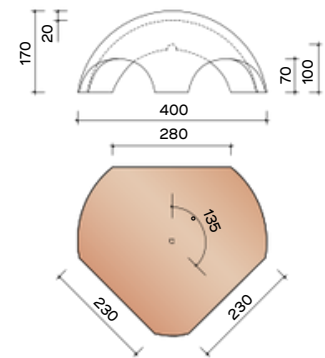

**P0005740**  
Prince's hat between 1 frost 1200 and 2 north trees 3100

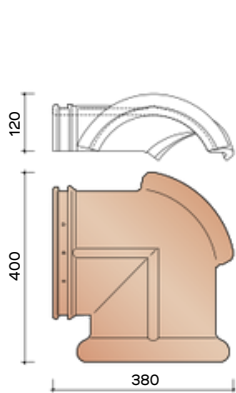

**P0005120**  
Connecting piece between 2 princes 1200 and 1 north tree 3100

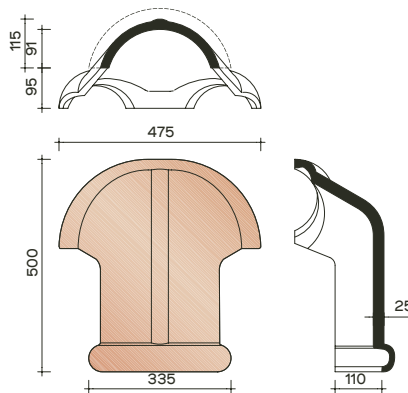

**P0005250**  
Connection piece between 1 frost 1200 and 2 north trees 3100

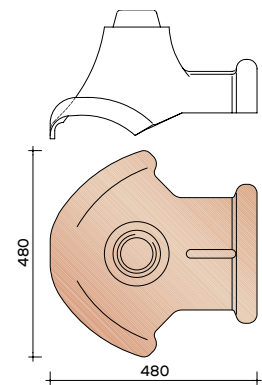

**P0005290**  
Connection piece between 1 frost 1200 and 2 north trees 3100 with ball connection

## TECHNICAL INFORMATION - OTHER ACCESSORIES

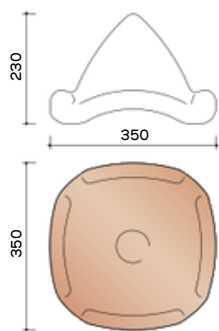

**P0005630**  
Connection piece between 4  
north trees 3100

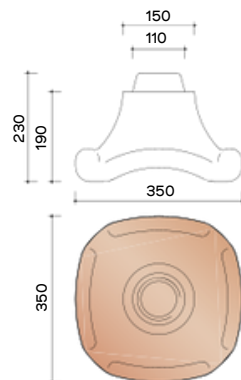

**P0005640**  
Connection piece between 4  
north poles 3100 with ball  
connection

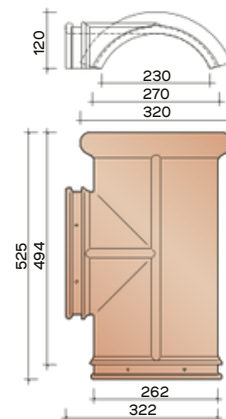

**P0005020**  
Connection piece between 3  
kings 1200

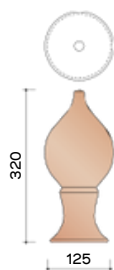

**P0005930**  
Piron No. 4

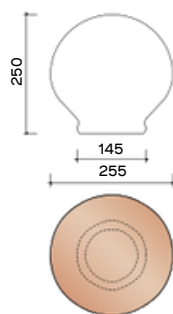

**P0005950**  
Sphere for connector with spherical  
connection In combination with  
P0005640 and P0005290

# LOHAS

## CONTACT US

P 02 9566 2114  
E [info@lohasau.com](mailto:info@lohasau.com)

W [lohasau.com](http://lohasau.com)  
IG [@lohas\\_australia](https://www.instagram.com/lohas_australia)

LOHAS Australia is a proud distributor of the Wienerberger product range.

