

CELENIT

NATURAL INSULATORS



LOHAS
Australia

ACOUSTIC | DESIGN
APPLICATION GUIDE

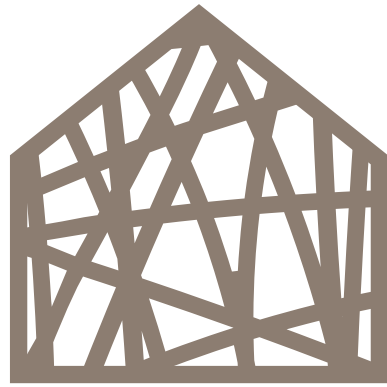

ACOUSTIC | DESIGN

Index

FALSE CEILINGS

VISIBLE T PROFILE	5
HIDDEN T PROFILE	15
HIDDEN METAL STRUCTURE	23
HIDDEN WOODEN STRUCTURE	41

WALL COVERINGS

HIDDEN METAL STRUCTURE	51
HIDDEN WOODEN STRUCTURE	65

COVERINGS WITH MECHANICAL FIXINGS

75

BAFFLE

BAFFLE BASIC	85
BAFFLE SMART	91

TECHNICAL SPECIFICATIONS

COLORS	98
SUSTAINABILITY	100
SOUND ABSORPTION	101
IMPACT RESISTANCE	106
FIRE RESISTANCE	107
STORAGE, USE AND MAINTENANCE	108

NOTE	110
-------------	-----



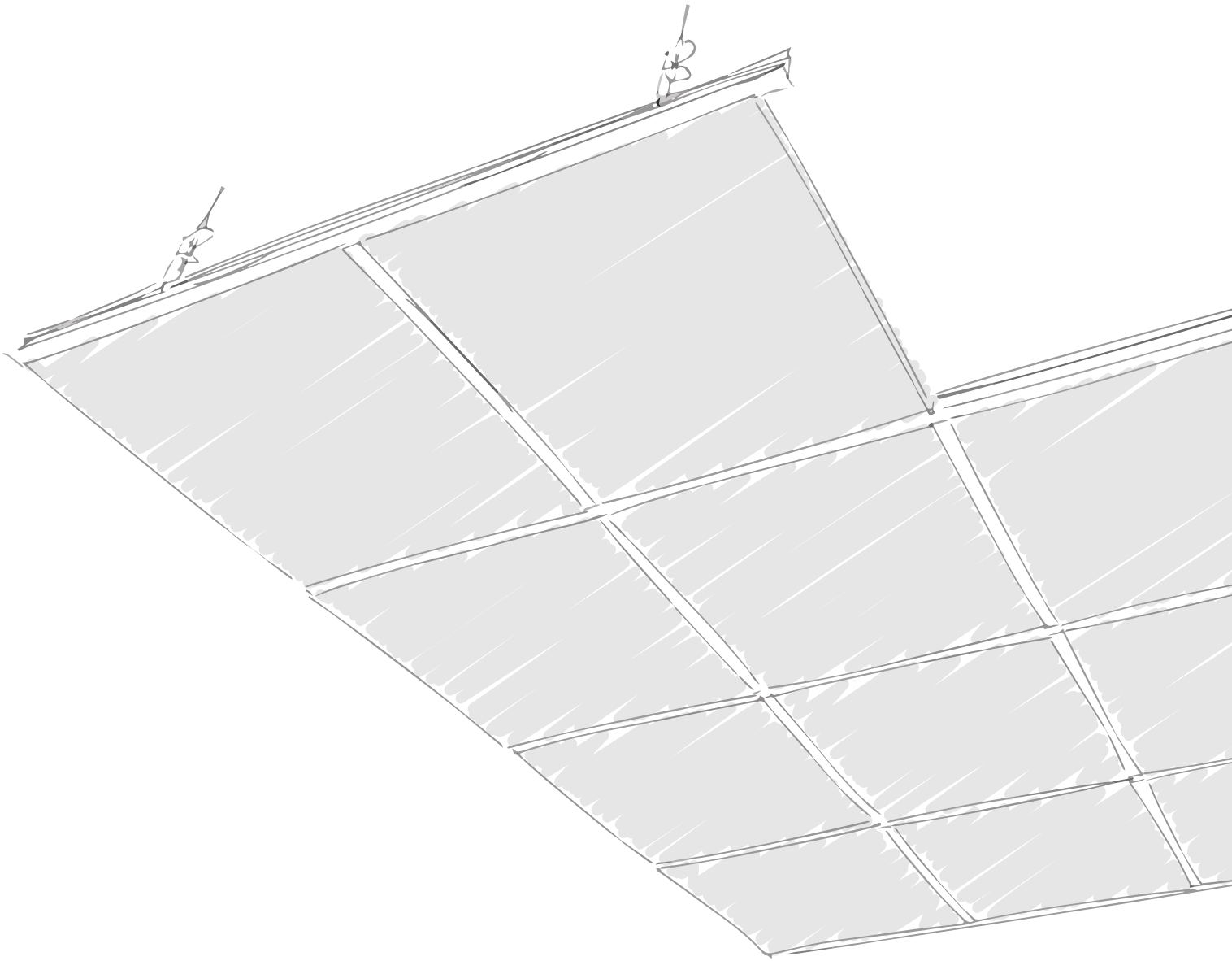

FALSE CEILINGS
VISIBLE T PROFILE

Item specifications

CELENIT sound absorbing false ceiling with visible T profile, model ACOUSTIC ..., with thermal and acoustic insulation, eco-friendly and sound absorbing boards - CELENIT ... product range, CELENIT ... item No. ... - made of mineralized ... fir wood wool bound with white Portland cement, it complies with EN 13168 and EN 13964 standards, it can be coupled with rock wool (ACOUSTIC MINERAL product range); dim.: ... x ... mm; th.: ... mm; texture: ...; ... edges (code: ...); weight: ... kg/m²; λ_D : ... W/mK; R_D : ... m²K/W; compressive stress σ_{10} : \geq ... kPa; water vapour transmission μ : 5; reaction to fire: Euroclass B-s1, d0 or A2-s1, d0 (EN 13501-1 standard); sound absorption: α_w ... / NRC ...; durability: class C; light reflection:

50.7 or 74.0% (painted white 05/15); release of formaldehyde: class E1; it does not contain asbestos. Wood wool boards must be certified by ANAB-ICEA and natureplus for eco-compatibility of materials and manufacturing process, PEFC™ or FSC® for the sustainability of wood raw material, ICEA for the content of recycled material and for the attestation of LEED credits, EPD for the environmental statement. Main bearing T... profile every ... mm, cross T... profile every ..., suspended by adjustable hanger.

Products



CELENIT ACOUSTIC range
ABE - AB

CELENIT ACOUSTIC A2 range
ABE/A2 - AB/A2

Boards made of mineralized wood wool bound with white Portland cement



Straight edges
DT for thicknesses 15 - 25 mm



Straight edges
T for thicknesses 35 mm



Shiplap edges
RDT for thicknesses 25 - 35 mm with T24 profile
RDT35 for thicknesses 25 - 35 mm with T35 profile



Shiplap and chamfered edges
RST for thicknesses 25 - 35 mm with T24 profile
RST35 for thicknesses 25 - 35 mm with T35 profile



CELENIT ACOUSTIC MINERAL range
L2ABE15 - L2AB15
L2ABE25 - L2AB25

CELENIT ACOUSTIC MINERAL A2 range
L2ABE15/A2 - L2AB15/A2
L2ABE25/A2 - L2AB25/A2

Boards made of mineralized wood wool bound with white Portland cement coupled to a layer of rock wool with non woven glass fibre



Straight edges
DTL for all boards with T35 profile

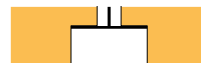

Shiplap edges
RDTL for CELENIT L2ABE25 - CELENIT L2AB25 - CELENIT L2ABE25/A2 - CELENIT L2AB25/A2 boards with T35 profile

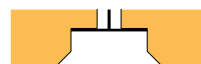

Shiplap and chamfered edges
RSTL for CELENIT L2ABE25 - CELENIT L2AB25 - CELENIT L2ABE25/A2 - CELENIT L2AB25/A2 boards with T35 profile

Installation system

SUSPENDED T24 PROFILE

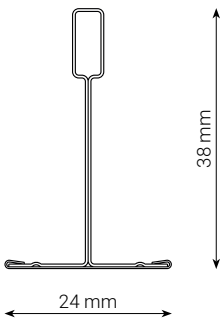
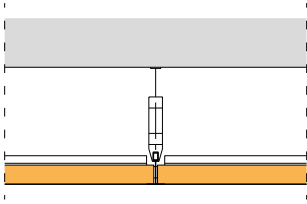

Specific for CELENIT ACOUSTIC range.

Profiles dimensions

Main bearing T profile section 24x38 mm, length 3600 mm.

Cross T profile section 24x38 mm, length 600 mm.

Standard visible strip white, black, silver painted (RAL paint available on demand).

Panel dimensions

Thicknesses 15 - 25 mm.

Dimensions 595x595 - 1195x595 - 1995x595 mm.

Installation scheme

Bearing T profiles fixed every 600 mm.

Cross T profile fixed according to panel length (600 - 1200 - 2000 mm).

Hangers

Adjustable hanger with hanging ring.

Minimum suspensions 150 mm insulation excluded.

Ball hits resistance system available on demand (see certificate at page 11).

SUSPENDED T35 PROFILE

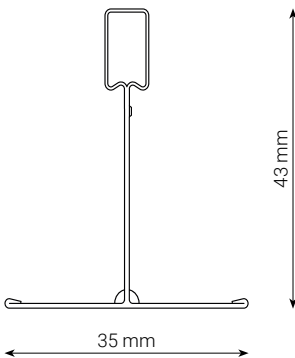
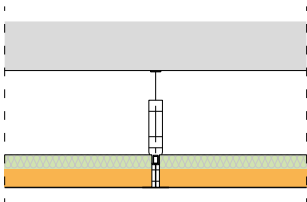

Specific for CELENIT ACOUSTIC MINERAL range.
Available for CELENIT ACOUSTIC range.

Profiles dimensions

Main bearing T profile section 35x43 mm, length 3600 mm.

Cross T profile section 35x43 mm, length 600 mm.

Standard visible strip white, black, silver painted (RAL paint available on demand).

Panel dimensions

Wood wool thicknesses 15 - 25 - 35 mm.

CELENIT ACOUSTIC MINERAL panels dimensions 1193x590 mm.

CELENIT ACOUSTIC panels dimensions 595x595 - 1195x595 - 1995x595 mm.

Installation scheme

Bearing T profiles fixed every 600 mm.

Cross T profile fixed every 1200 mm for CELENIT ACOUSTIC MINERAL panels.

Cross T profile fixed according to panel length (600 - 1200 - 2000 mm) for CELENIT ACUSITC panels.

Hangers

Adjustable hanger with hanging ring.

Minimum suspensions 150 mm insulation excluded.

The profiles can be anticorrosion treated on demand for high relative humidity applications: swimming pools, saunas, kitchens, changing rooms of gym and health centers.

Suspended T24 profile

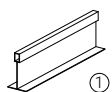
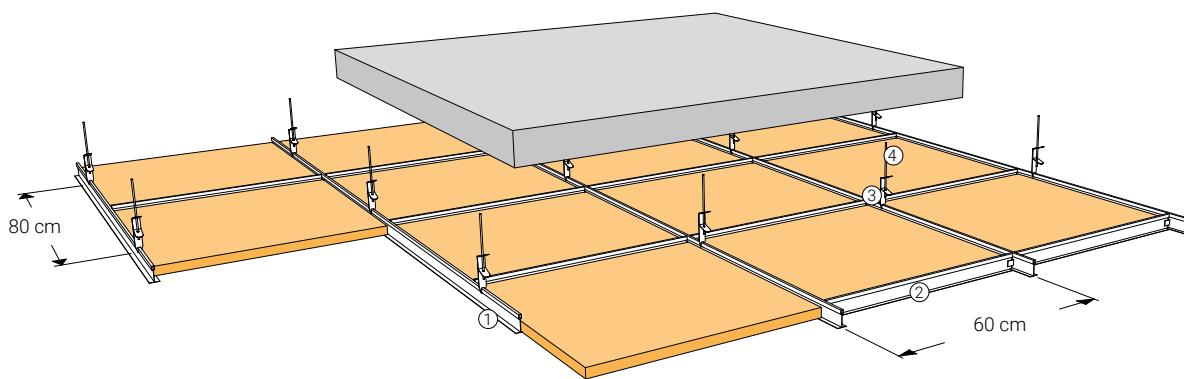
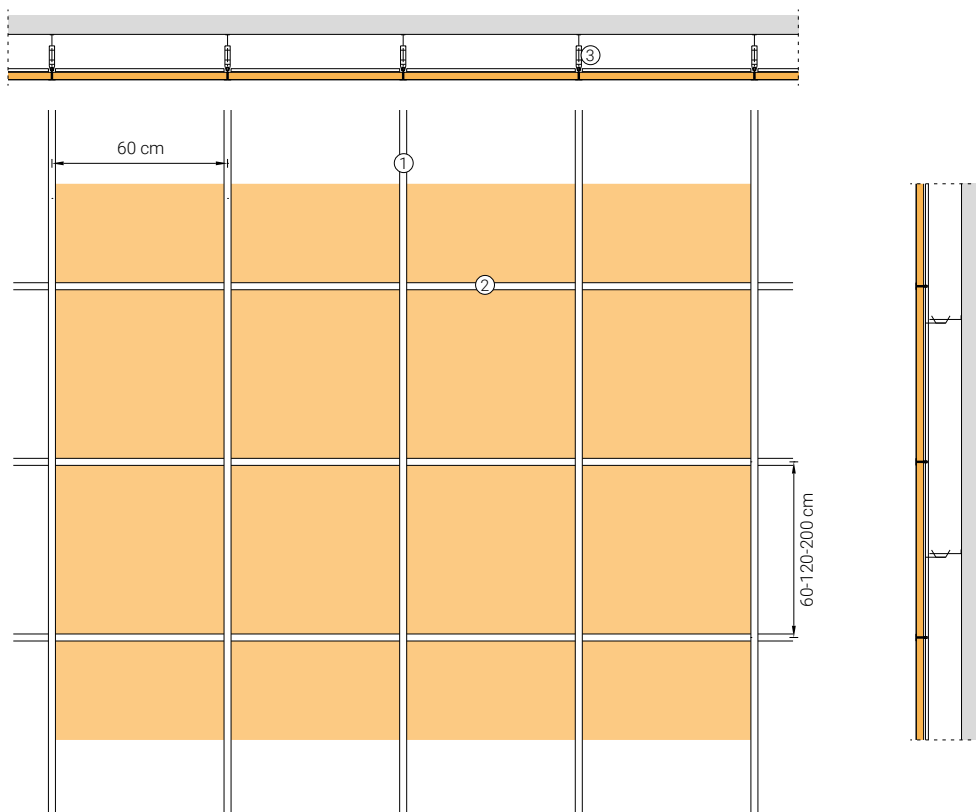

Bearing profile
section 24x38 mm, length 3600 mm
visible strip painted

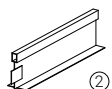

Cross profile
section 24x38 mm, length 600 mm
visible strip painted



Adjustable hanger



Hanger with metal ring
diameter 4 mm
length 25-50-100-200-300 cm

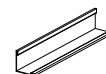

L Perimeter bracket
section 24x24 mm, length 3000 mm

Suspended T35 profile

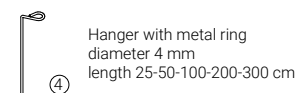
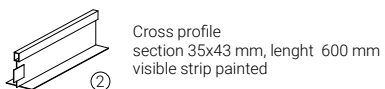
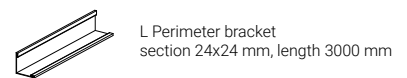
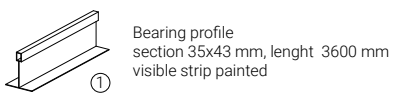
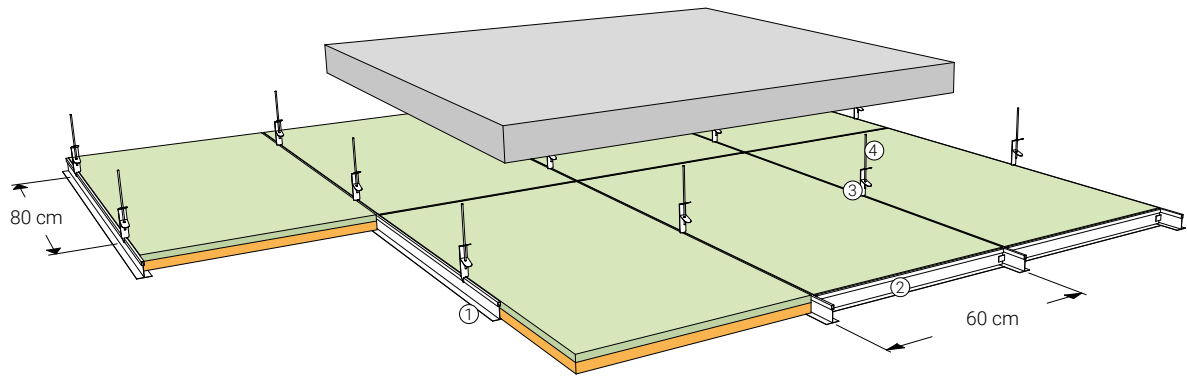
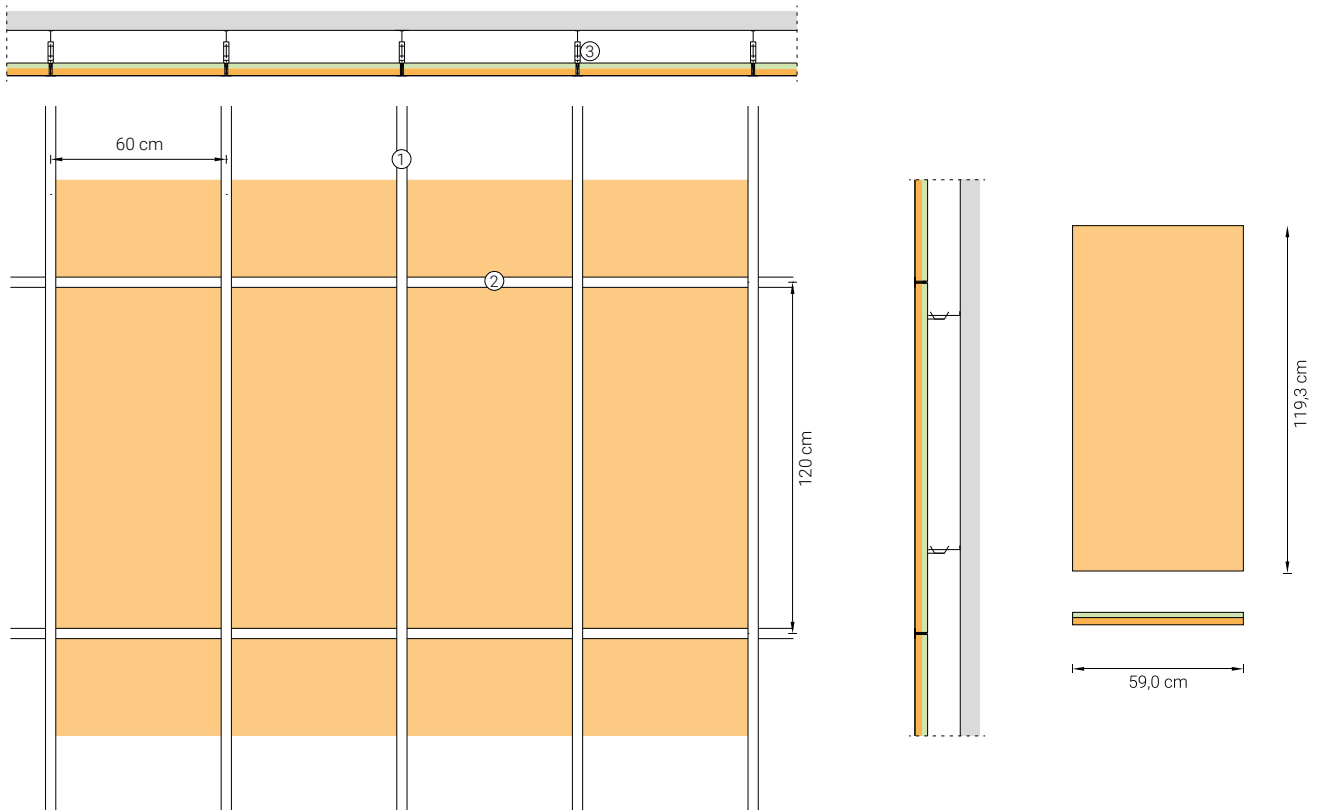

Indicative quantities

CELENIT ACOUSTIC range

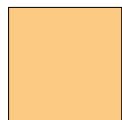

Dimensions: 595x595 mm
Bearing profile every 600 mm
Cross profile every 600 mm
Spacing between hangers: ≤ 800 mm



Dimensions: 1995x595 mm
Bearing profile every 600 mm
Cross profile every 2000 mm
Spacing between hangers: ≤ 800 mm



Dimensions: 1195x595 mm
Bearing profile every 600 mm
Cross profile every 1200 mm
Spacing between hangers: ≤ 800 mm

Type	Section [mm]	Spacing [mm]	Indicative quantities		
			595x595 mm	1195x595 mm	1995x595 mm
Hanger with metal ring ^{*2}	Φ 4	800 ^{*1}	2.10 pcs/m ²	2.10 pcs/m ²	2.10 pcs/m ²
Adjustable hanger	-	800 ^{*1}	2.10 pcs/m ²	2.10 pcs/m ²	2.10 pcs/m ²
Bearing profile	24x38	600	1.70 m/m ²	1.70 m/m ²	1.70 m/m ²
Cross profile	24x38	600/1200/2000	1.70 m/m ²	0.85 m/m ²	0.60 m/m ²
L Perimeter bracket	24x24	-	Perimeter ^{*3}		

CELENIT ACOUSTIC MINERAL range



Dimensions: 1193x590 mm
Bearing profile every 600 mm
Cross profile every 1200 mm
Spacing between hangers: ≤ 800 mm

Type	Section [mm]	Spacing [mm]	Indicative quantities
Hanger with metal ring ^{*2}	Φ 4	800 ^{*1}	2.10 pcs/m ²
Adjustable hanger	-	800 ^{*1}	2.10 pcs/m ²
Bearing profil	35x43	600	1.70 m/m ²
Cross profile	35x43	1200	0.85 m/m ²
L Perimeter bracket	24x24	-	Perimeter ^{*3}

^{*1} The spacing between the hangers is the distance between them along the bearing profile.

^{*2} The length of the hangers with metal ring is depending on desired suspension. Galvanized steel hangers are recommended. The quantity of profiles/hangers varies in function of the spacing.

^{*3} The quantities of the L Perimeter bracket is the total perimeter of the false ceiling

False ceiling with CELENIT AB 25 mm thick, ball impact resistant
according to EN 13964/Attached D standard

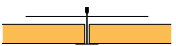
	Type of board	Structure	Certificate ¹ No. / Date	Standard	Results
	CELENIT AB Thickness: 25 mm Dimensions: 1200x600 mm Edges: Straight - DT	Bearing T profile section 24x38 mm Cross profile every 600 mm Bearing profile every 1200 mm Cross profile every 600 mm Anti-lift pin: 2 per board	200535 22.08.2005	EN 13964	Class 1A

¹ The certificate is based on tests carried out at the Giordano Institute (Bellaria - RN - Italy)

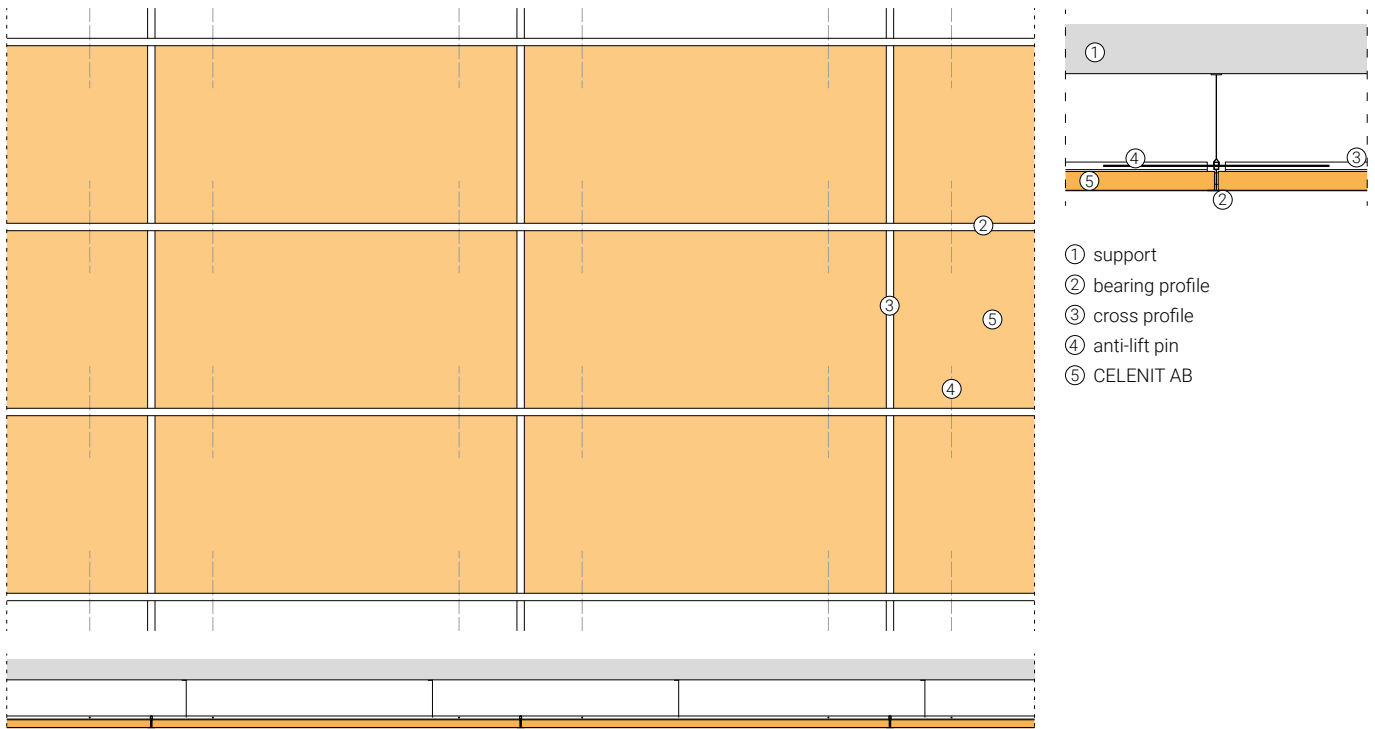

- ① support
- ② bearing profile
- ③ cross profile
- ④ anti-lift pin
- ⑤ CELENIT AB

Description

CELENIT AB boards dimensions 1195x595 mm, 25 mm thick, with straight edges (code DT), leaning on the support structure consisting of:

- main joists made of T-shaped profile, nominal section 24x38 mm, distance between centers 600 mm;
- cross joists made of T-shaped profile, nominal section 24x38 mm, distance between centers 1200 mm.

The main joists must be equipped with a special hole in the high part of the profile. A anti-lift pin will be inserted into the hole to ensure fall protection (2 pin per board). Anti-lift pin are galvanized steel bars, diameter 4 mm and length 300 mm. See the certificate for further information of installation.

Classification: **CLASS 1A**

Test results

Impacts	Impact angle	Nominal velocity [m/s]	Visual examination *	Class
12	90°	16.5 ± 0.8	No deformation and/or change	1A
12	60°		No deformation and/or change	1A
12	60° (opposite direction)		No deformation and/or change	1A

* As specified by clause D.6 "Evaluation" of EN 13964:2014 standard

Storage, use and maintenance

The boards must be stored on a pallet placed on a flat surface, protected from rain and direct sunlight. Pallets must be handled with care on site. Bumping the corners of the pallets can cause damage to the boards. For more information see the "Storage, use and maintenance" (page 108) information available in the download area of the website www.celenit.com.



CELENIT boards are dimensionally stable (EN 13168), however, they must be installed after acclimating to the same room they are going to be installed in, as well as after all concrete works are finished and the doors, windows, heating and ventilation systems have been installed.

Room temperature must be kept constant before and after installation. Do not suddenly change the temperature of the room after installation.

General installation instructions

- The boards have one side that should be visible (front of the board) and another side that should be placed against the structure (back of the board). The back of the board usually has the CELENIT logo or shows calibration marks. The front may be painted and/or has worked edges. In the absence of paint or edges, the front can be identified according to the pallet layout: the front of the boards faces the top and the back faces the pallet.
- With the aid of a laser level mark the positions for the fixings of the hangers (fixing must be chosen according to the ceiling texture and the loading of the structure) and drill the holes, then connect the hangers to the fixings.
- With the aid of a laser level trace the desired height of the false ceiling on the wall and fix the L perimeter bracket
- Design the bearing profiles position starting from the center of the ceiling to have a symmetric layout.
- Connect the cross profiles to bearing profiles see page 10 for interaxes.
- Lay the panels on the profiles. Take maximum care while handling the panels. Corners and paint are easy to damage.

Use clean gloves when installing the panels. Please find more information on stocking, use and maintenance (page 108) at www.celenit.com.

- 1200x600 mm panels can be staggered on long sides.
- It is possible to insert mineral wool panels or wood fiber panels on top of CELENIT panels to improve acoustic and thermal performances while laying CELENIT boards.
- After the installation please follow the recommendations in the section "Storage, use and maintenance" (page 108) at www.celenit.com.

Important remarks

15 mm panels are not recommended for outdoor applications (with a roof protection) or in presence of high humidity. When passing an order for panel with a T profile, make sure to specify you need them for a T profile or indicate the right dimension: 595/1195/1995x595 mm. Exact dimensions panels 2000/1200/600x600 are not suitable for a T profiles structure.



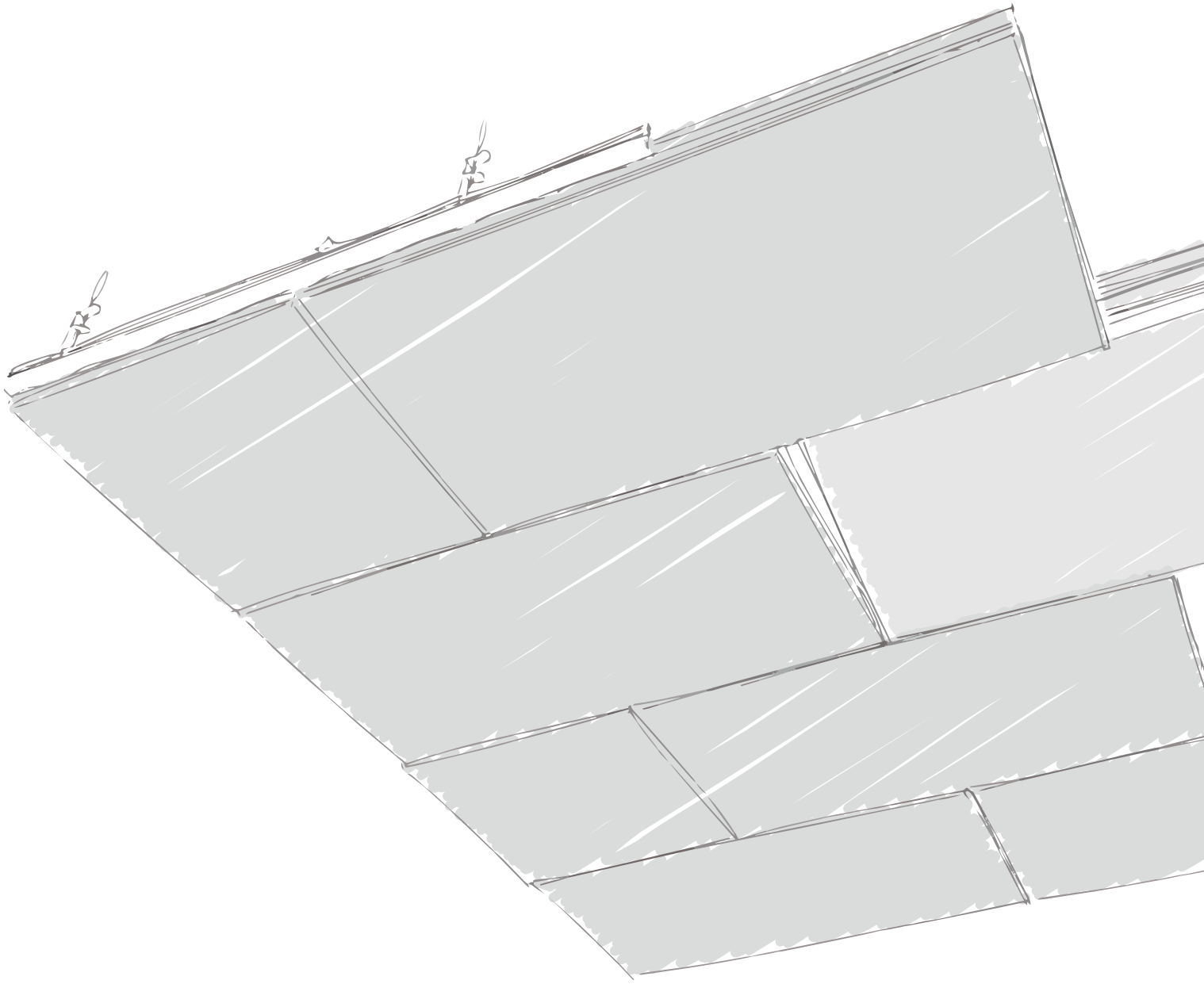

FALSE CEILINGS
HIDDEN T PROFILE

Item specifications

CELENIT sound absorbing and inspectionable false ceiling with hidden T35 profile, model ACOUSTIC ..., with thermal and acoustic insulation, eco-friendly and sound absorbing boards - CELENIT ... product range, CELENIT ... item No. ... - made of mineralized ... fir wood wool bound with white Portland cement, it complies with EN 13168 and EN 13964 standards, it can be coupled with rock wool (ACOUSTIC MINERAL product range); dim.: ... x ... mm; th.: ... mm; texture: ...; straight edges (code: D) or chamfered edges (code: S4); weight: ... kg/m²; λ_D : ... W/mK; R_D : ... m²K/W; compressive stress σ_{10} : \geq ... kPa; water vapour transmission μ : 5; reaction to fire: Euroclass B-s1, d0 or A2-s1, d0 (EN 13501-1 standard); sound absorption: α_w ... / NRC ...; durability: class C; light reflection:

50.7 o 74.0% (painted white 05/15); release of formaldehyde: class E1; it does not contain asbestos. Wood wool boards must be certified by ANAB-ICEA and natureplus for eco-compatibility of materials and manufacturing process, PEFC™ or FSC® for the sustainability of wood raw material, ICEA for the content of recycled material and for the attestation of LEED credits, EPD for the environmental statement. Bearing T35 profiles fixed every 600 mm, suspended by adjustable hangers; connecting element for hidden structure.

Products



CELENIT ACOUSTIC range
ABE - AB

CELENIT ACOUSTIC A2 range
ABE/A2 - AB/A2

Boards made of mineralized wood wool bound with white Portland cement

Edges detail

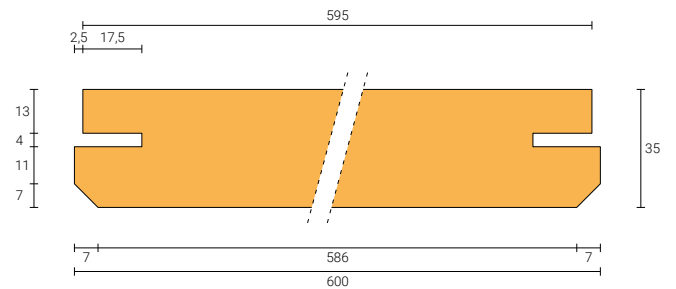
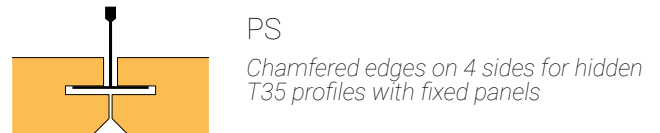
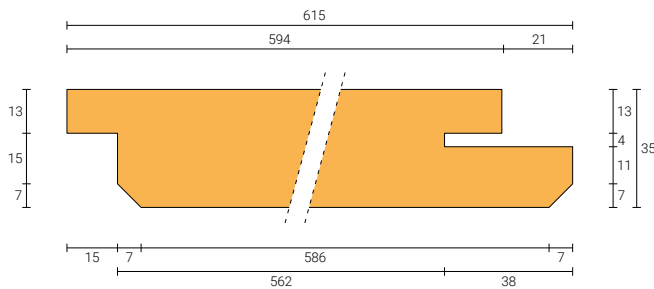
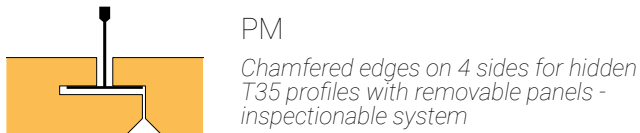

Installation system

Inspectionable hidden structure with removable panels - PM edge

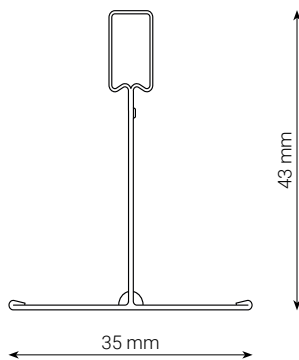
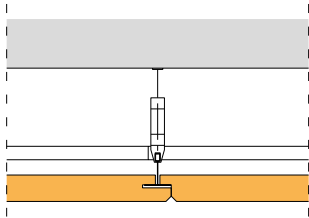

Inspectionable. PM edge allows you to hide the structure and provide mobility of the panel.

Profiles dimensions

Main bearing T profile section 35x43 mm, length 3600 mm.

Connecting element for hidden structures section 25x25 mm, length 625 mm.

Panel dimensions

Thickness 35 mm.

Dimensions 600x600 - 1200x600 mm.

Installation scheme

Bearing T profiles fixed every 600 mm.

Connecting element for hidden structure every 1200 mm (see notes on page 20).

Hangers

Adjustable hanger with hanging ring.

Minimum suspensions 150 mm insulation excluded.

Hidden structure with fixed panels - PS edge

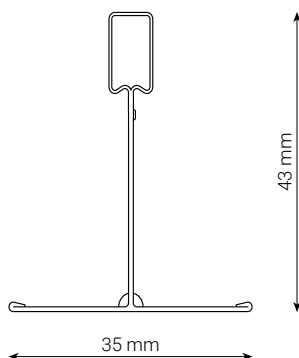
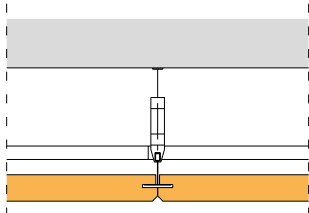

Profiles dimensions

Main bearing T profile section 35x43 mm, length 3600 mm.

Connecting element for hidden structures section 25x25 mm, length 625 mm.

Panel dimensions

Thicknesses 25 - 35 mm.

Dimensions 600x600 - 1200x600 mm.

Installation scheme

Bearing T profiles fixed every 600 mm.

Connecting element for hidden structure every 1200 mm (see notes on page 20).

Hangers

Adjustable hanger with hanging ring.

Minimum suspensions 150 mm insulation excluded.

The profiles can be anticorrosion treated on demand for high relative humidity applications: swimming pools, saunas, kitchens, changing rooms of gym and health centers.

Inspectionable hidden structure with removable panels

T35 profile, boards with PM edge

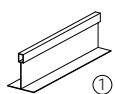
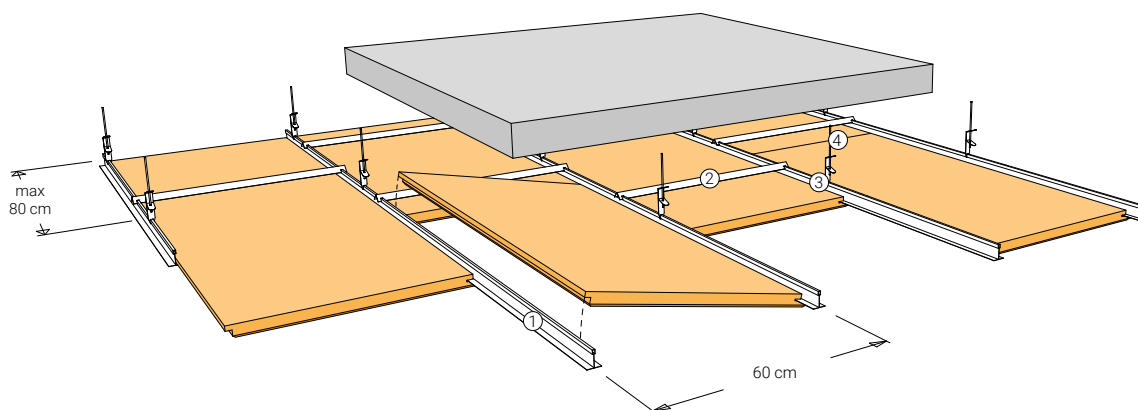
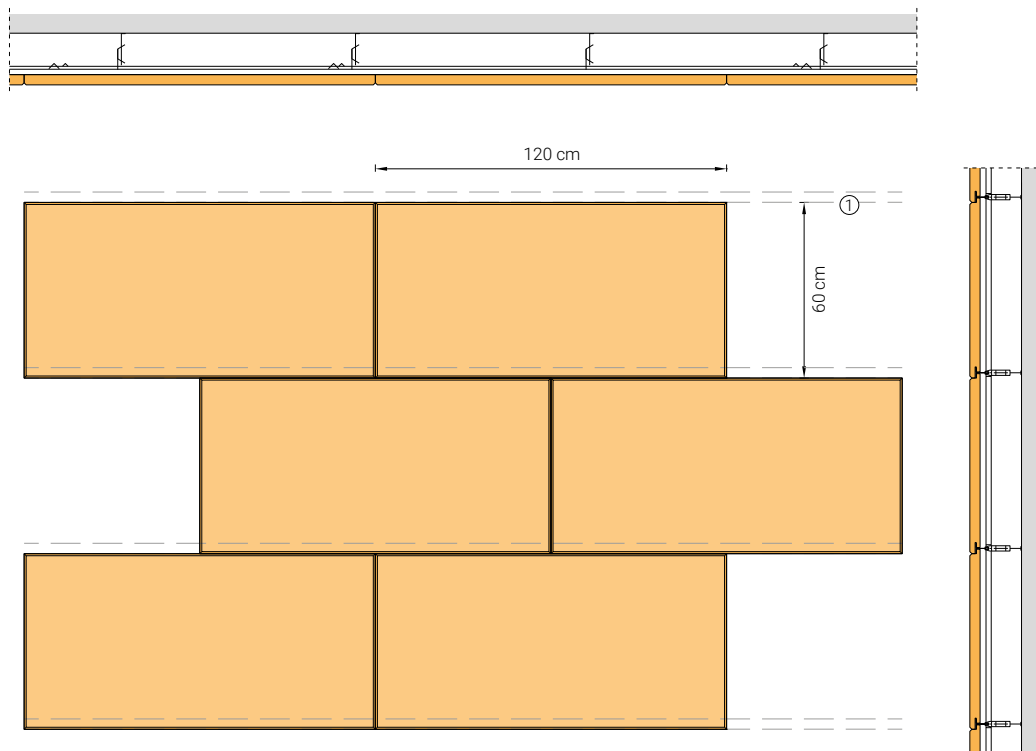

Bearing profile
section 35x43 mm, length 3600 mm



Adjustable hanger

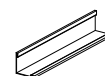

L Perimeter bracket
section 24x24 mm, length 3000 mm

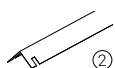

Connecting element for hidden structure
section 25x25 mm, length 625 mm



Hanger with metal ring
diameter 4 mm
length 25-50-100-200-300 cm

Hidden structure with fixed panels

T35 profile, boards with PS edge

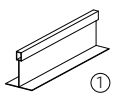
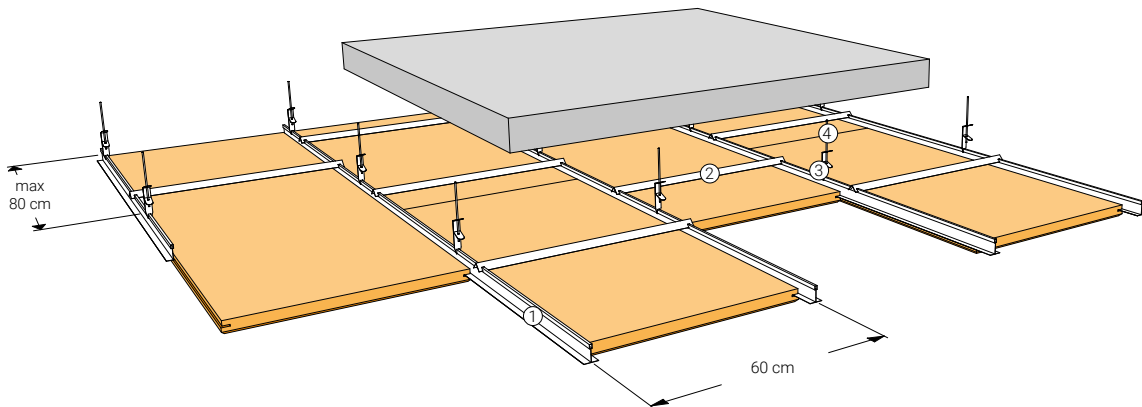
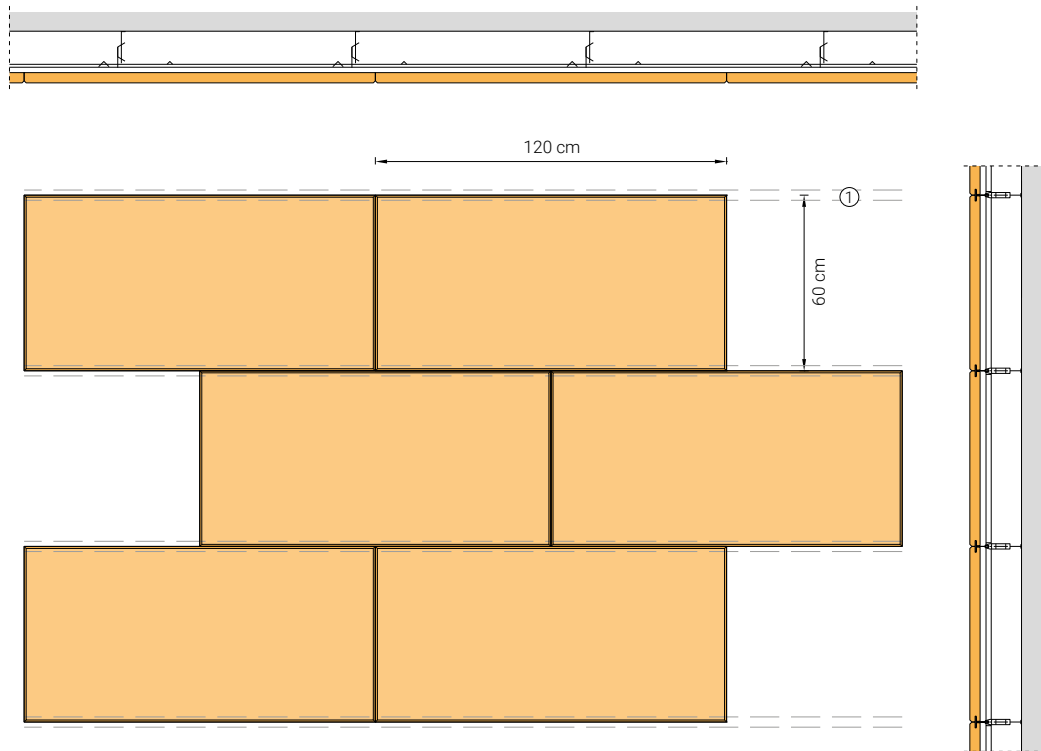

Bearing profile
section 35x43 mm, length 3600 mm



Adjustable hanger

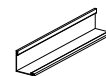

L Perimeter bracket
section 24x24 mm, length 3000 mm

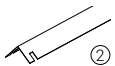

Connecting element for hidden structure
section 25x25 mm, length 625 mm



Hanger with metal ring
diameter 4 mm
length 25-50-100-200-300 cm

Indicative quantities

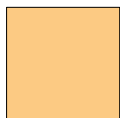

Dimensions 600x600 mm
 Connecting element every 800 mm
 Bearing profile every 600 mm
 Spacing between hangers: ≤ 800 mm



Dimensions 1200x600 mm
 Connecting element every 800 mm
 Bearing profile every 600 mm
 Spacing between hangers: ≤ 800 mm

Type	Section [mm]	Spacing [mm]	Indicative quantities
Hanger with metal ring *2	Φ 4	800 *1	2.10 pcs/m ²
Adjustable hanger	-	800 *1	2.10 pcs/m ²
Bearing profile	35x43	600	1.70 m/m ²
Connecting element	25x25	1200 *3	1.92 pcs/m ²
L Perimeter bracket	24x24	-	Perimeter *4

*1 The spacing between the hangers is the distance between them along the bearing profile.

*2 The length of the hangers with metal ring is depending on desired suspension. Galvanized steel hangers are recommended. The quantity of profiles/hangers varies in function of the spacing.

*3 The spacing of between connecting elements is not bound to the length of the panels, as it will not remain visible but will be anchored directly in the upper part of the supporting profile. The spacing 1200 mm is only indicative of the quantities. For 60x60 cm boards with PM edge, the installation of connecting elements will be "alternating panels" in the longitudinal direction: the first panel will have 1 element, while the next one will not. For 120x60 cm boards with PM edge, the installation of connecting elements will be "alternating panels" in the longitudinal direction: the first panel will have 2 element, while the next one will not.

*4 The quantities of the L Perimeter bracket is the total perimeter of the false ceiling

Examples of installation of connecting elements

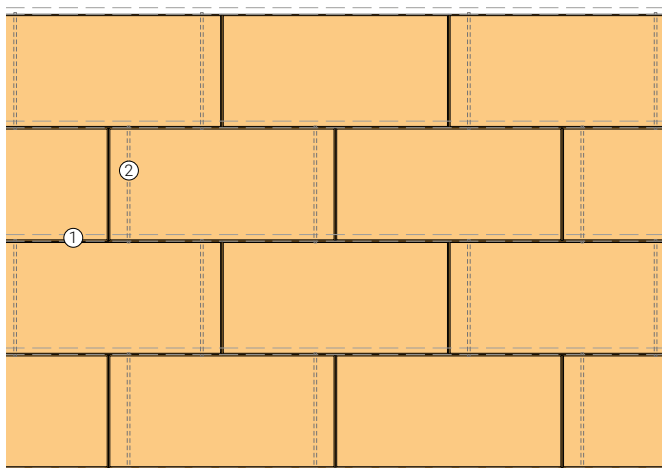

120x60 cm boards with PM edge

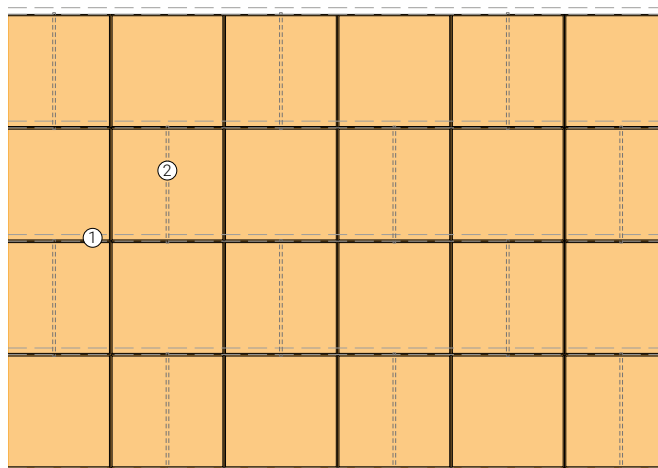

60x60 cm boards with PM edge

- ① Bearing T35-profile
- ② connecting element

Storage, use and maintenance

The boards must be stored on a pallet placed on a flat surface, protected from rain and direct sunlight. Pallets must be handled with care on site. Bumping the corners of the pallets can cause damage to the boards. For more information see the "Storage, use and maintenance" information (page 108) available in the download area of the website www.celenit.com.



CELENIT boards are dimensionally stable (EN 13168), however, they must be installed after acclimating to the same room they are going to be installed in, as well as after all concrete works are finished and the doors, windows, heating and ventilation systems have been installed.

Room temperature must be kept constant before and after installation. Do not suddenly change the temperature of the room after installation.

General installation instructions

- The boards have one side that should be visible (front of the board) and another side that should be placed against the structure (back of the board). The back of the board usually has the CELENIT logo or shows calibration marks. The front may be painted and/or has worked edges. In the absence of paint or edges, the front can be identified according to the pallet layout: the front of the boards faces the top and the back faces the pallet.
- With the aid of a laser level mark the positions for the fixings of the hangers (fixing must be chosen according to the ceiling texture and the loading of the structure) and drill the holes, then connect the hangers to the fixings.
- With the aid of a laser level trace the desired height of the false ceiling on the wall and fix the L perimeter bracket.
- Design the bearing profiles position starting from the center of the ceiling to have a symmetric layout.
- Lay the panels on the profiles and at the same time lay the

connecting element on the bearing profile with an appropriate distance. Take maximum care while handling the panels. Corners and paint are easy to damage. Use clean gloves when installing the panels. Please find more information on stocking, use and maintenance (page 108) at www.celenit.com.

- It is possible to insert mineral wool panels or wood fiber panels on top of CELENIT panels to improve acoustic and thermal performances while laying CELENIT boards.
- After the installation please follow the recommendations in the section "Storage, use and maintenance" (page 108) at www.celenit.com.



f Emma "mangiava un gelato mantecato, che veniva con
la mano sinistra in una conchiglia di vetro, gli occhi
semichiusi, il cucchiaino tra i denti."

Gabriele Piaceri

d "Mamma! What sweets are we going to have?" Natasha again
cried boldly... "Ice pudding, but you won't get any," said Maria
Dmitrievna... Natasha only desisted when she had been told that
there would be pineapple ice.

"La nonna spoghiò i cibi del loro sapore.
Alla fine della cena furono serviti dei gelati chiamati pombiere. Tintano
che questo tipo di gelato contiene piccoli frutti cosparsi delicatamente
sopra il gelato, che viene servito in un piccolo bicchiere senza coprire la sua
forma a piramide."

Francesca Basso

The ladies were reminded of the
of eating, delicious as it was, being
the plus or minus of their past life.

Chiara Gugliotta

"Quei pombieri di cui parlavo...
Lui e lei, e sono da un pezzo che
che non sono più come un tempo
sorriso, con un sospiro di lei."

Questo gelato era
mangiato...
piaceva tanto...
che non si poteva...

Il gelato era
mangiato...
che non si poteva...

Chiara Gugliotta

Informational counter with a colorful graphic strip (blue, green, orange, purple) and text in Italian. The text includes: "DALLA FINE DELL'AMARO AL MIELE, IL BISCOTTO...".

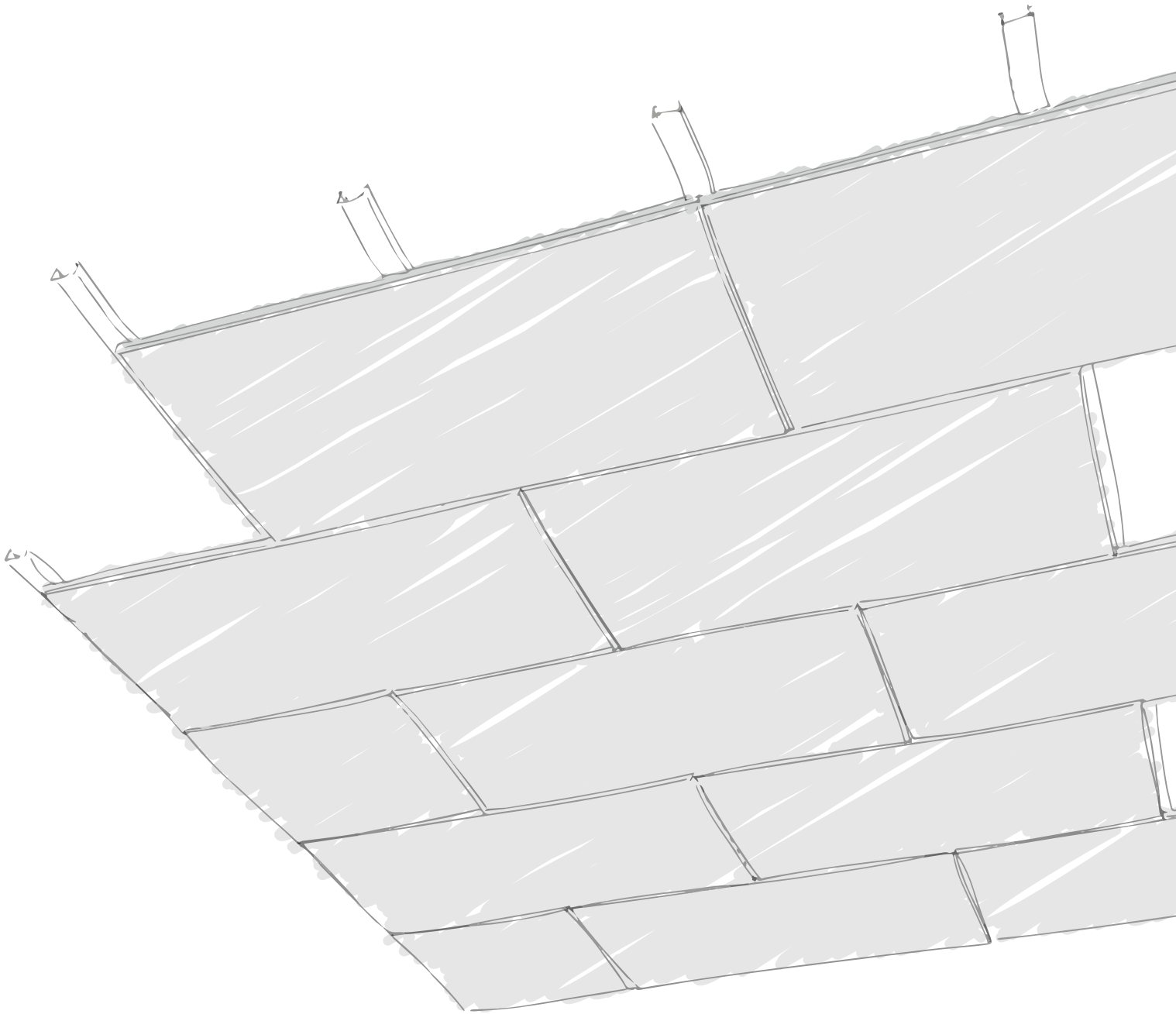

FALSE CEILINGS
**HIDDEN METAL
STRUCTURE**

Item specifications

CELENIT sound absorbing false ceiling with hidden metal structure, model ACOUSTIC ..., with thermal and acoustic insulation, eco-friendly and sound absorbing boards - CELENIT ... product range, CELENIT ... item No. ... - made of mineralized ... fir wood wool bound with white Portland cement, it complies with EN 13168 and EN 13964 standards, it can be coupled with rock wool (ACOUSTIC MINERAL product range); dim.: ... x ... mm; th.: ... mm; texture: ...; straight edges (code: D) or chamfered edges (code: S4); weight: ... kg/m²; λ_D : ... W/mK; R_D : ... m²K/W; compressive stress σ_{10} : \geq ... kPa; water vapour transmission μ : 5; reaction to fire: Euroclass B-s1, d0 or A2-s1, d0 (EN 13501-1 standard); sound absorption: α_w ... / NRC ...; durability: class C; light reflection: 50.7 or 74.0% (painted white 05/15); release of formaldehyde:

class E1; it does not contain asbestos.

Wood wool boards must be certified by ANAB-ICEA and natureplus for eco-compatibility of materials and manufacturing process, PEFC™ or FSC® for the sustainability of wood raw material, ICEA for the content of recycled material and for the attestation of LEED credits, EPD for the environmental statement.

C profiles 60x27 or C 50x27 with ... mm spacing, suspended by fixed spacers/adjustable brackets or supported by clip profiles/C profiles, suspended by hangers. Fixings per boards: ...; screws diameter: 3.5 mm; fixings scheme: ... x ... mm.

Products



CELENIT ACOUSTIC range
ABE - AB

CELENIT ACOUSTIC A2 range
ABE/A2 - AB/A2

Boards made of mineralized wood wool bound with white Portland cement



Straight edges
D for all thicknesses



Chamfered edges
S4 for all thicknesses



Shiplap edges
RD10 for thicknesses 25 - 35 mm
RD20 for thicknesses 25 - 35 mm



CELENIT ACOUSTIC MINERAL range
L2ABE25 - L2AB25 - L2ABE25C

CELENIT ACOUSTIC MINERAL A2 range
L2ABE25/A2 - L2AB25/A2 - L2ABE25C/A2

Boards made of mineralized wood wool bound with white Portland cement coupled to a layer of rock wool



Straight edges
D for all thicknesses



Chamfered edges
S4 for all thicknesses

The boards are supplied with dimensions 1200x600 mm with rock wool 1200x500 mm, for direct application to the structure.

Except for **L2ABE25C** and **L2ABE25C/A2** which are supplied with rock wool 1200x600 mm and sufficient compression strength to avoid crushing during the laying. They can be screwed directly to the structure, either with orthogonal or parallel installation.

Adhered application

Available for CELENIT ACOUSTIC boards or CELENIT ACOUSTIC MINERAL boards with rock wool thickness until 40 mm.

System with fixed spacer

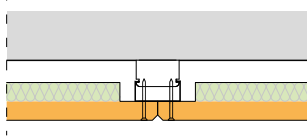

- The system with fixed spacer allows to have a single structure, replacing the primary structure and containing the lowering.
- Spacers anchored to the ceiling with suitable fixings depending on the type of the support.
- Maximum distance between spacers 80 cm.
- The boards will be fixed directly to the C profiles according to the fixing schemes (page 31).

System with adjustable bracket

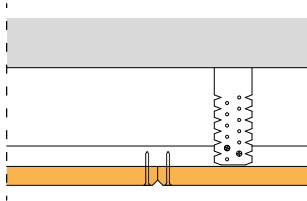

- The system with adjustable bracket allows to have a single structure, replacing the primary structure and containing the lowering.
- The bracket allows adjustable air-gap.
- Spacers anchored to the ceiling with suitable fixings depending on the type of the support.
- Maximum distance between bracket 80 cm.
- The boards will be fixed directly to the C profiles according to the fixing schemes (page 31).
- Maximum suspensions 10 cm, insulation excluded.

Suspended application

Available for CELENIT ACOUSTIC boards or CELENIT ACOUSTIC MINERAL boards with rock wool thickness 18 - 25 mm.

System with clip steel profile

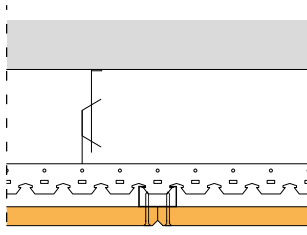

- Lowering elements (hanger or steel wire) anchored to the ceiling with suitable fixings depending on the type of the support.
- Maximum distance between lowering elements 80 cm.
- C profiles fixed on clip steel profile, with a maximum distance of 60 cm.
- The boards will be fixed directly to the C profiles according to the fixing schemes (page 31).
- Minimum suspensions 15 cm, insulation and profiles excluded.

System with double C profiles

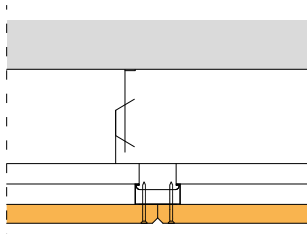

- Lowering elements (hanger or steel wire) anchored to the ceiling with suitable fixings depending on the type of the support.
- Maximum distance between lowering elements 80 cm.
- Secondary C profiles with a maximum distance of 60 cm, fixed to the primary C profiles with a clip hook.
- The boards will be fixed directly to the C profiles according to the fixing schemes (page 31).
- Minimum suspensions 15 cm, insulation and profiles excluded.

The profiles can be anticorrosion treated on demand for high relative humidity applications: swimming pools, saunas, kitchens, changing rooms of gym and health centers.

Orthogonal installation to the structure

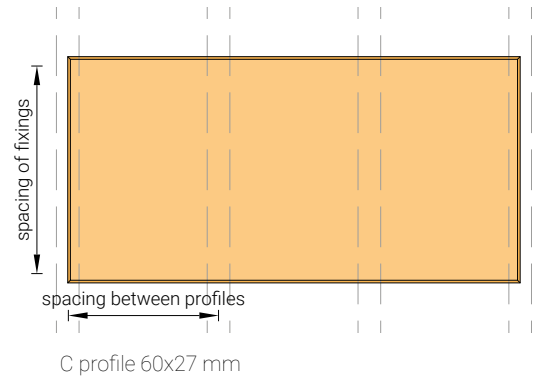
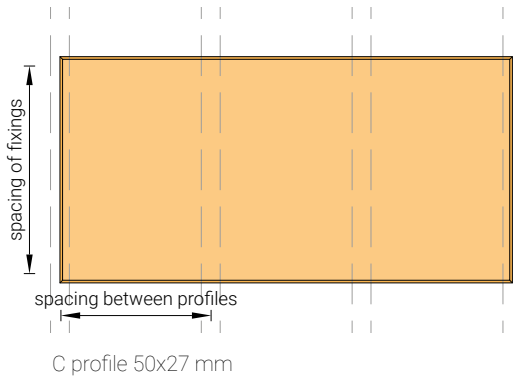

Only for CELENIT ACOUSTIC panels

- Secondary C profile fixed according to panel length. Generally C profile are fixed every 400 mm or 600 mm; for boards length 2000 mm C profiles can be fixed every 500 mm.
- Secondary C profile dimensions 50x27x0.6 mm; also available section 60x27 mm.
- System anchored to the ceiling with suitable fixings depending on the type of the support.

Parallel installation to the structure

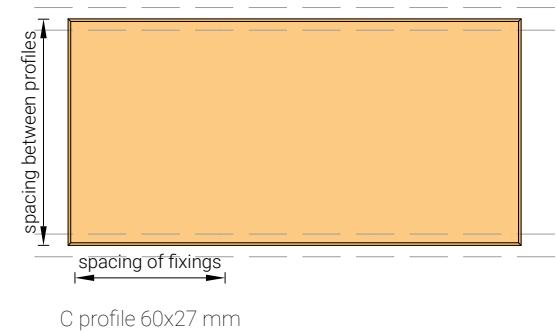
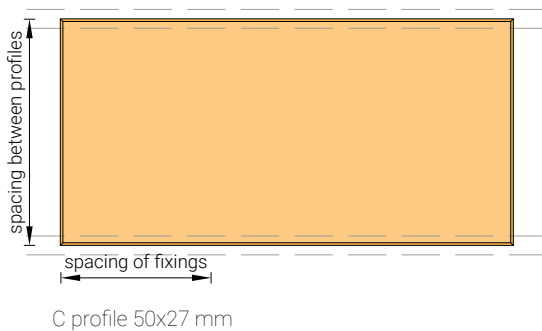

Available for CELENIT ACOUSTIC MINERAL boards or CELENIT ACOUSTIC boards

- System generally used for adhered application, to containing the lowering.
- Secondary C profile fixed every 600 mm.
- Secondary C profile dimensions 50x27x0.6 mm; also available section 60x27 mm.
- System anchored to the ceiling with suitable fixings depending on the type of the support.

Adhered application system with fixed spacers and C profiles

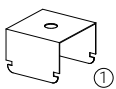
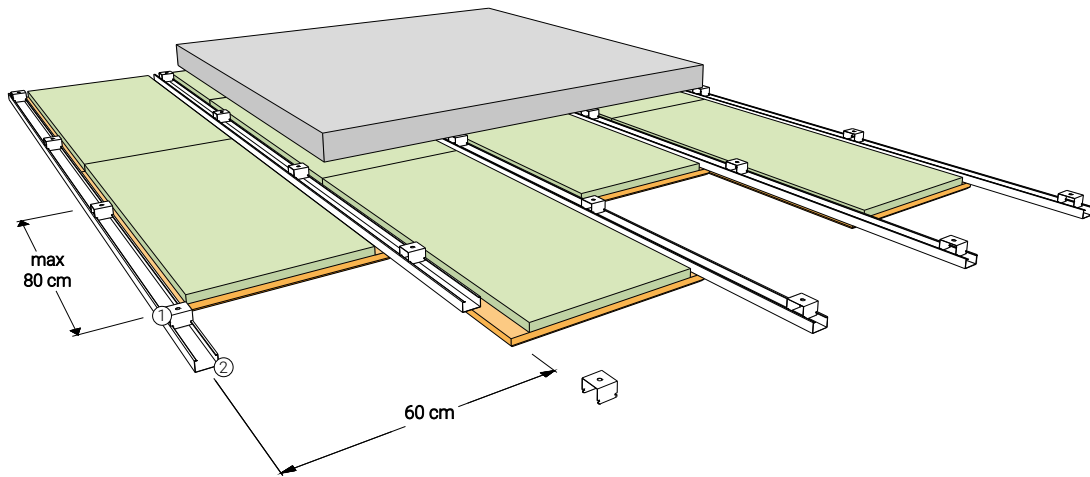
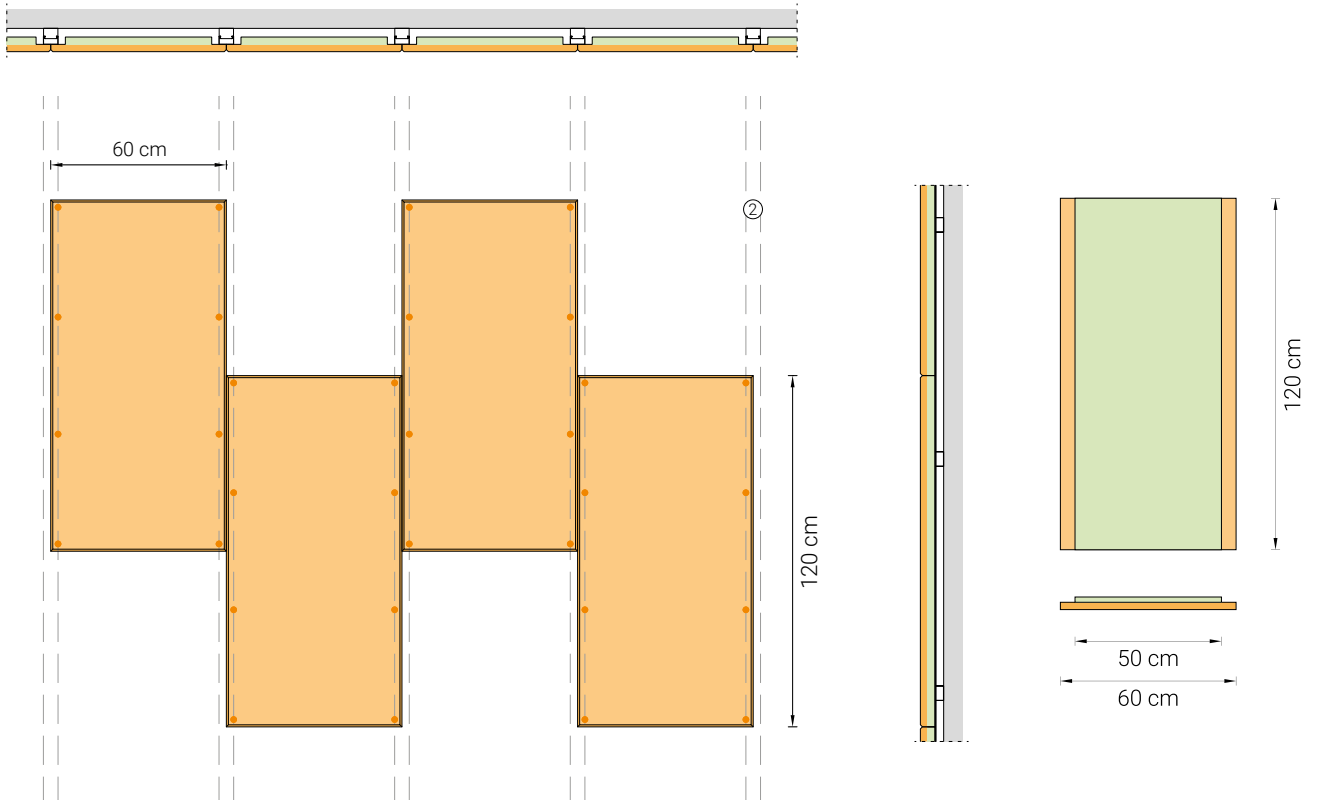

Galvanized steel fixed spacer for C profile
Dimensions 50x30 mm or 60x30 mm,
rounded edge

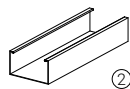

Galvanized steel C profile
Dimensions 27x50x27 mm
or 27x60x27 mm,
thickness 0.6 mm, rounded
edge



Selftapping steel screw for plasterboard
Countersunk head
Dimensions 3.5x35 - 3.5x45 - 3.5x55 mm

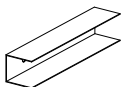

U-shaped perimeter guide
Dimensions 28x30x28 mm
Thickness 0.6 mm

Adhered application system with adjustable brackets and C profiles

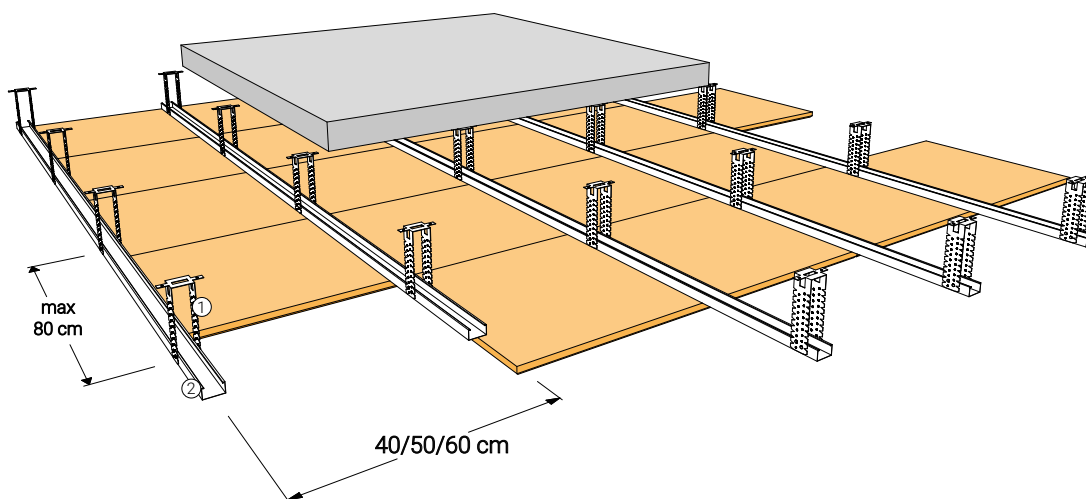
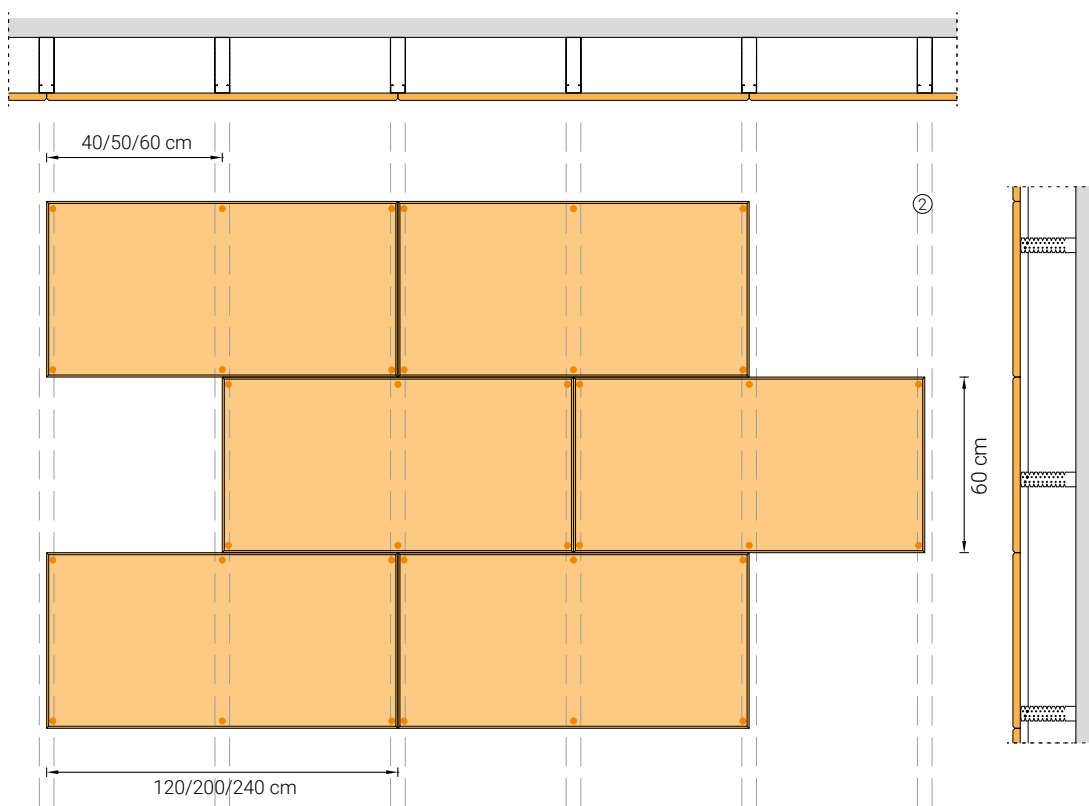

Adjustable steel bracket for C profile
Width 50 mm or 60 mm

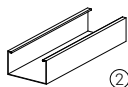

Galvanized steel C profile
Dimensions 27x50x27 mm
or 27x60x27 mm,
thickness 0.6 mm, rounded
edge



Selftapping steel screw for plasterboard
Countersunk head
Dimensions 3.5x35 - 3.5x45 - 3.5x55 mm

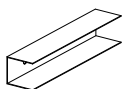

U-shaped perimeter guide
Dimensions 28x30x28 mm
Thickness 0.6 mm

Suspended application system with clip steel profiles and C profiles

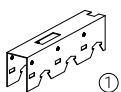
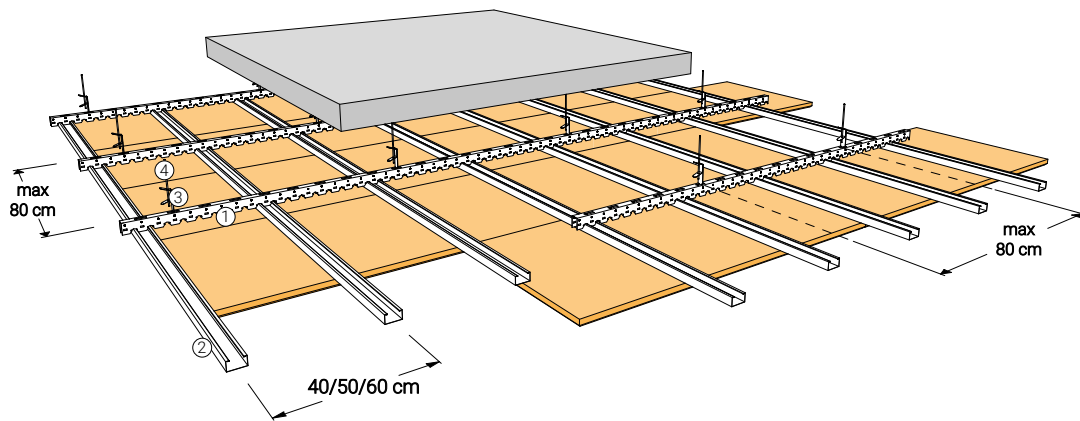
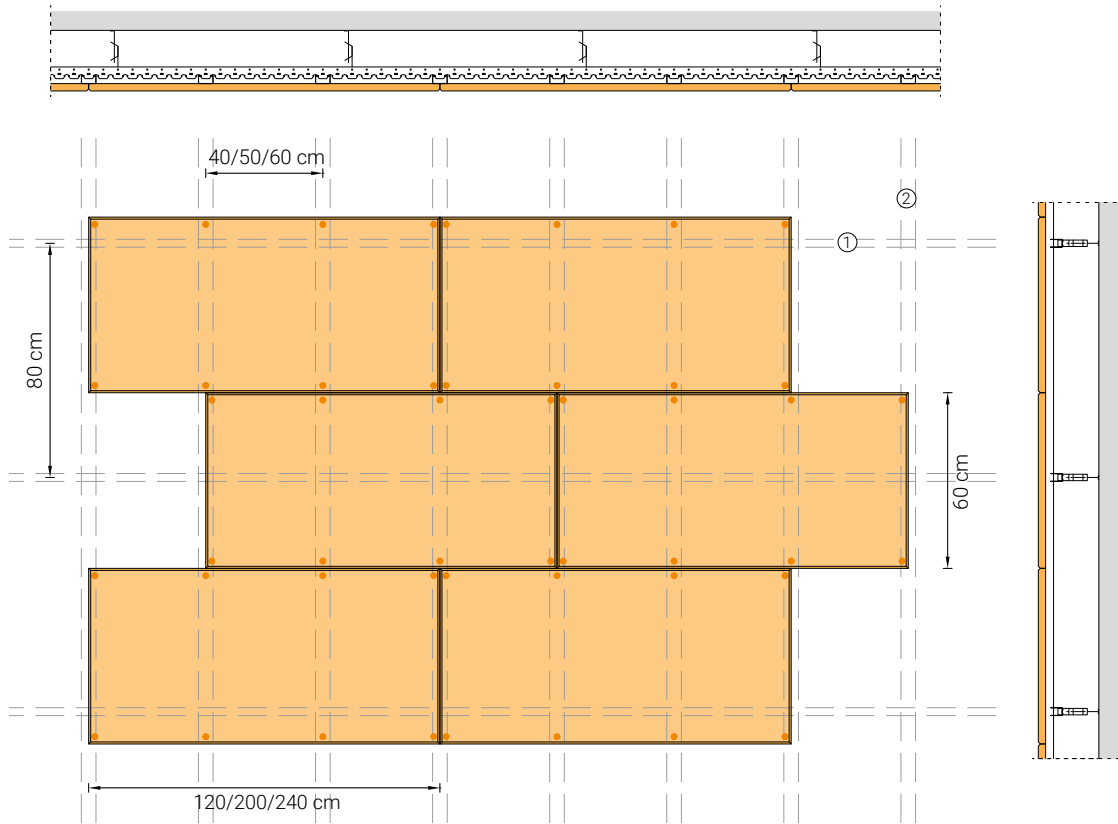

① Primary galvanized steel clip profile for C profile
Dimensions 28x40 mm, thickness 0.6 mm, rounded edge



③ Adjustable hanger for clip profile



Selftapping steel screw for plasterboard
Countersunk head
Dimensions 3.5x35 - 3.5x45 - 3.5x55 mm

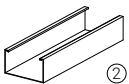

② Galvanized steel C profile
Dimensions 27x50x27 mm or 27x60x27 mm, thickness 0.6 mm, rounded edge



④ Hanger with metal ring
diameter 4 mm

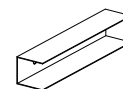

U-shaped perimeter guide
Dimensions 28x30x28 mm
Thickness 0.6 mm

Suspended application system with double C profiles

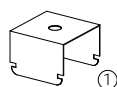
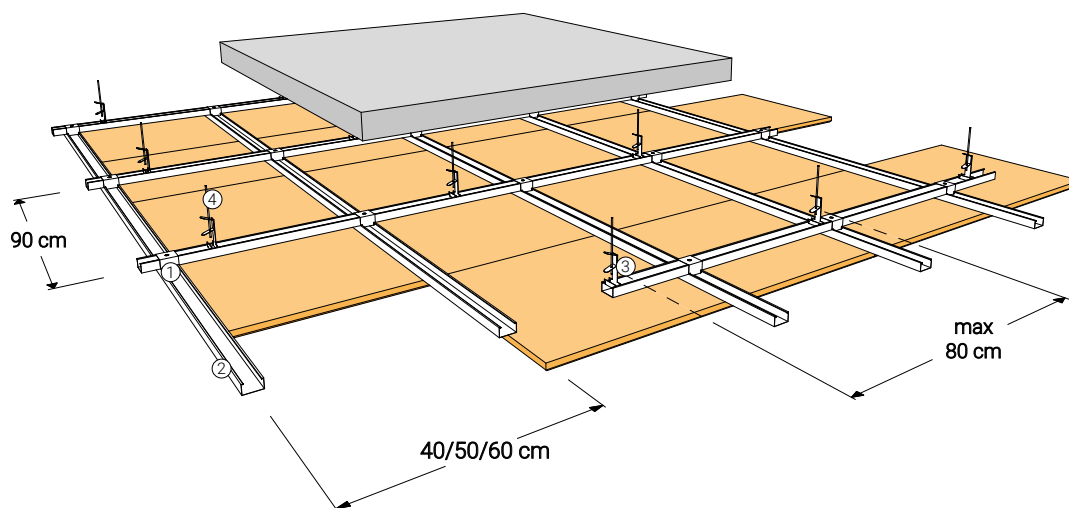
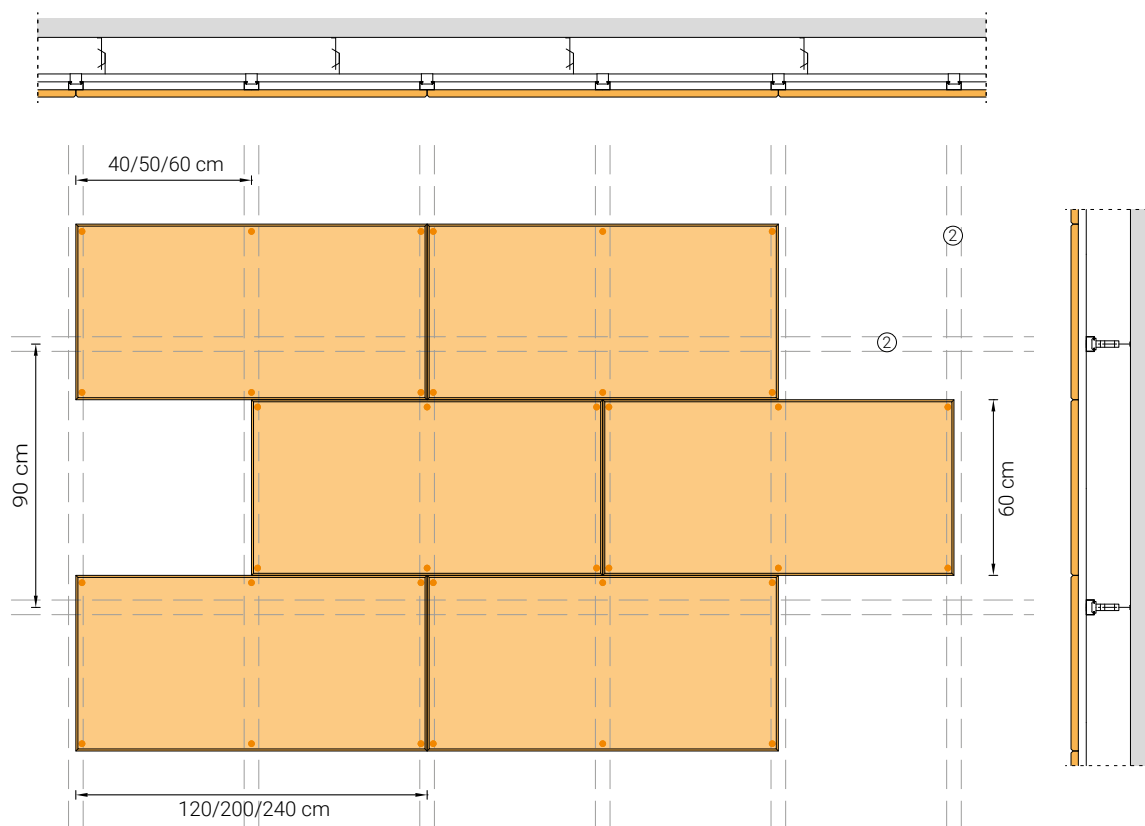

Galvanized steel fixed spacer for C profile
Dimensions 50x30 mm or 60x30 mm,
rounded edge



Adjustable hanger for C profile



Selftapping steel screw for plasterboard
Countersunk head
Dimensions 3.5x35 - 3.5x45 - 3.5x55 mm

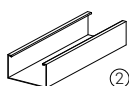

Galvanized steel C profile
Dimensions 27x50x27 mm or 27x60x27
mm, thickness 0.6 mm, rounded edge



Hanger with metal ring
diameter 4 mm

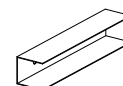

U-shaped perimeter guide
Dimensions 28x30x28 mm
Thickness 0.6 mm

C 27x60x27 profiles must be used for false ceiling ball-impact resistant by adjusting the size of the fixed spacers and the hangers (see pages 33-34).

Fixings schemes

CELENIT ACOUSTIC range

• thickness 15 mm

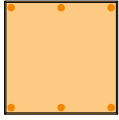

600x600 mm - 6 screws
Orthogonal installation:
Spacing of fixings 600 mm
C profile fixed every 300 mm

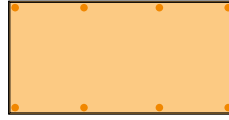

1200x600 mm - 8 screws
Orthogonal installation:
Spacing of fixings 600 mm
C profile fixed every 400 mm

• thicknesses 25/35 mm

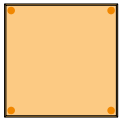

600x600 mm - 4 screws
Orthogonal/parallel installation:
Spacing of fixings 600 mm
C profile fixed every 600 mm

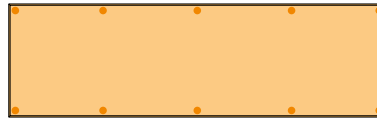

2000x600 mm - 10 screws
Parallel installation:
Spacing of fixings 500 mm
C profile fixed every 600 mm
Orthogonal installation:
Spacing of fixings 600 mm
C profile fixed every 500 mm



1200x600 mm - 8 screws
Parallel installation:
Spacing of fixings 400 mm
C profile fixed every 600 mm
Orthogonal installation:
Spacing of fixings 600 mm
C profile fixed every 400 mm



2400x600 mm - 10 screws
Orthogonal/parallel installation:
Spacing of fixings 600 mm
C profile fixed every 600 mm

Board thickness [mm]	Dimensions [mm]	Screws per board [No.]	Screws per m ² [No./m ²]	Spacing between profile [mm]	Screw dimensions [mm]
15	600x600	6	16.7	300	3.5x35
	1200x600	8	11.2	400	
25	600x600	4	11.2	600	3.5x45
	1200x600	8	11.2	400 *	
	2000x600	10	8.4	500	
35	2400x600	10	7.0	600	3.5x55
	600x600	4	11.2	600	
	1200x600	8	11.2	400 *	
	2000x600	10	8.4	500	
	2400x600	10	7.0	600	

* C profile every 600 mm are also available, with screws spacing 300 mm and 9 screws per board (12.5 fixings/m²)

CELENIT ACOUSTIC MINERAL range

• wood wool thickness 25 mm



1200x600 mm - 8 screws
Parallel installation:
Spacing of fixings 400 mm
C profile fixed every 600 mm

Wood wool board thickness [mm]	Dimensions [mm]	Screws per board [No.]	Screws per m ² [No./m ²]	Spacing between profile [mm]	Screw dimensions [mm]
25	1200x600	8	11.2	600	3.5x45

Indicative quantities

Adhered application system with fixed spacers and C profiles

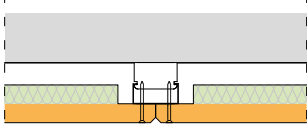

Type	Section [mm]	Length [mm]	Spacing [mm]	Indicative quantities
Galvanized steel fixed spacer for C profile	50x30 (60x30)	-	800 *1	2.10 pcs/m ² C profiles every 600 mm
				2.50 pcs/m ² C profiles every 500 mm
				3.10 pcs/m ² C profiles every 400 mm
C profile	27x50x27 (27x60x27)	3000/4000	600	1.70 m/m ²
			500	2.00 m/m ²
			400	2.30 m/m ²
U-shaped perimeter guide	28x30x28	3000/4000	-	Perimeter *2

Adhered application system with adjustable brackets and C profiles

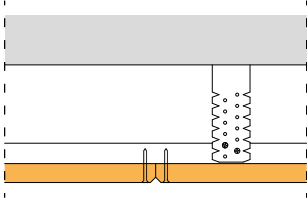

Type	Section [mm]	Length [mm]	Spacing [mm]	Indicative quantities
Adjustable steel bracket for C profile	50 (60)	-	800 *1	2.10 pcs/m ² C profiles every 600 mm
				2.50 pcs/m ² C profiles every 500 mm
				3.10 pcs/m ² C profiles every 400 mm
C profile	27x50x27 (27x60x27)	3000/4000	600	1.70 m/m ²
			500	2.00 m/m ²
			400	2.30 m/m ²
U-shaped perimeter guide	28x30x28	3000/4000	-	Perimeter *2

Suspended application system with clip steel profiles and C profiles

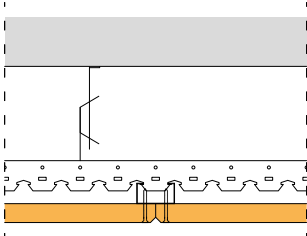

Type	Section [mm]	Length [mm]	Spacing [mm]	Indicative quantities
Hanger with metal ring	Φ 4	250/500/1000/ 1500/2000	800 *1	1.60 pcs/m ² clip profiles every 800 mm
				2.10 pcs/m ² clip profiles every 600 mm
Adjustable hanger for clip profile	-	-	800 *1	1.60 pcs/m ² clip profiles every 800 mm
				2.10 pcs/m ² clip profiles every 600 mm
Primary galvanized steel clip profile for C profile	40x28	4000	800	1.15 m/m ²
			600 *3	1.70 m/m ²
			600	1.70 m/m ²
C profile	27x50x27 (27x60x27)	3000/4000	500	2.00 m/m ²
			400	2.30 m/m ²
			-	Perimeter *2

Suspended application system with double C profiles

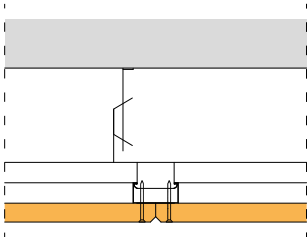

Type	Section [mm]	Length [mm]	Spacing [mm]	Indicative quantities
Hanger with metal ring	Φ 4	250/500/1000/ 1500/2000	800 *1	1.40 pcs/m ² C profiles every 900 mm
				1.60 pcs/m ² C profiles every 800 mm
				2.10 pcs/m ² C profiles every 600 mm
Adjustable hanger for C profile	-	-	800 *1	1.40 pcs/m ² C profiles every 900 mm
				1.60 pcs/m ² C profiles every 800 mm
				2.10 pcs/m ² C profiles every 600 mm
Primary C profile	27x50x27 (27x60x27)	3000/4000	900	1.11 m/m ²
			800	1.15 m/m ²
			600	1.70 m/m ²
Galvanized steel fixed spacer for C profile	50x30 (60x30)	-	-	- *4
Secondary C profile	27x50x27 (27x60x27)	3000/4000	600	1.70 m/m ²
			500	2.00 m/m ²
			400	2.30 m/m ²
U-shaped perimeter guide	28x30x28	3000/4000	-	Perimeter *2

*1 The spacing between the hangers is the distance between them along the bearing profile

*2 The quantities of the U-shaped guide is equal to the perimeter of the false ceiling

*3 Primary C profile fixed every 600 mm are required for false ceiling EI60 fire resistant (see page 35).

*4 The quantities of fixed spacer to use is equal to the number of crosses between primary structure and secondary structure

False ceiling with CELENIT AB 25 mm thick, ball impact resistant according to EN 13964/Attached D - DIN 18032/Part 3 standards

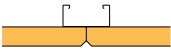
	Type of board	Structure	Certificate * No. / Date	Standard	Results
	CELENIT AB Thickness: 25 mm Dimensions: 1200x600 mm Edges: Chamfered - S4	C metal section 27x60x27 mm Distance between centers of cross joists: 600 mm Distance between centers of main joists: 900 mm Number of screws per board: 9	332601 31.03.2016	EN 13964	Class 1A
				DIN 18032-3	Visual examination Pass

* The certificate is based on tests carried out at the Giordano Institute (Bellaria - RN - Italy)

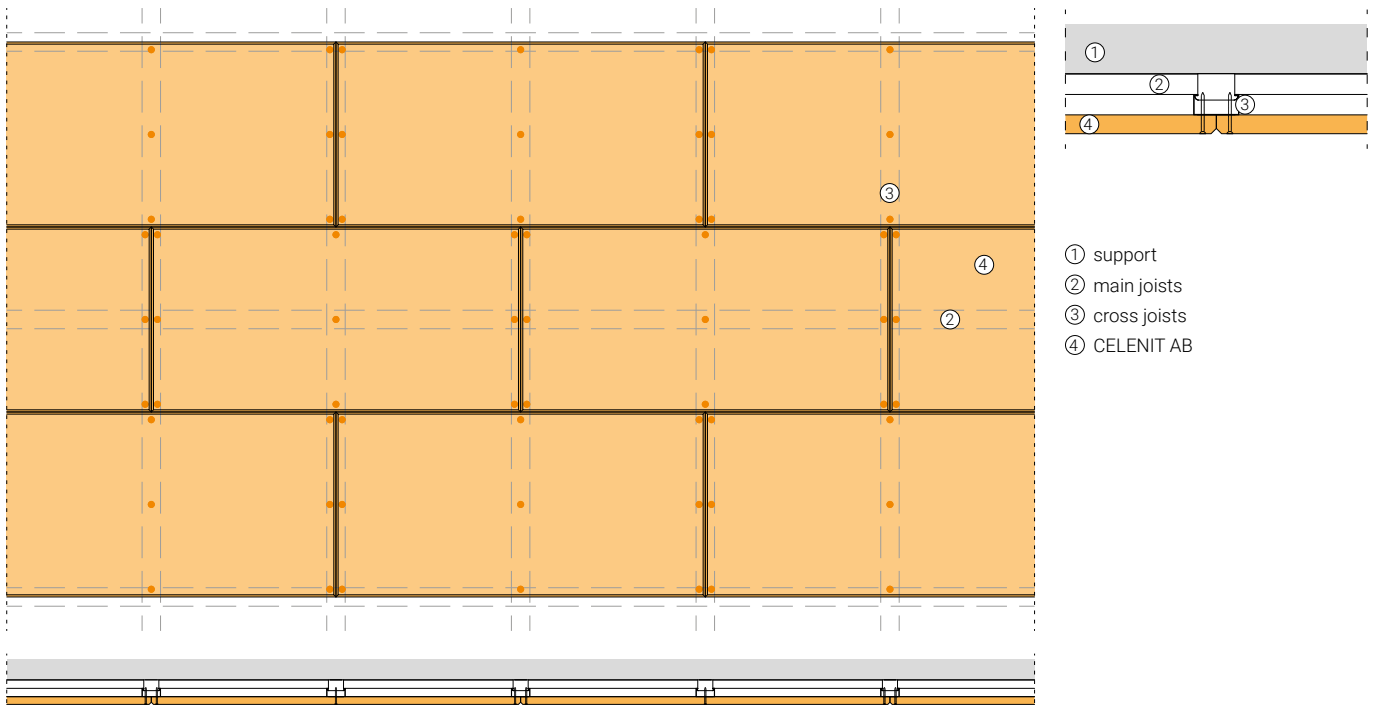

Description

CELENIT AB boards dimensions 1200x600 mm, 25 mm thick, with chamfered edges on 4 sides (code S4) with staggered laying on the short side. Boards are optionally painted and directly fixed to the cross joists made of C-shaped steel profile, section 60x27 mm and thickness 0.6 mm, placed orthogonally with a distance between centers of 600 mm. Cross joists

are supported by main joists made of C-shaped steel profile, section 60x27 mm and thickness 0.6 mm, placed orthogonally with a distance between centers of 900 mm. The boards are fixed on the underside to the cross joists using self-tapping screws, diameter 3.5 mm and spacing 300x600 mm (9 screws per board).

Classification: **CLASS 1A**

Test results

Impacts	Impact angle	Nominal velocity [m/s]	Visual examination *	Class
12	90°	16.5 ± 0.8	No deformation and/or change	1A
12	60°		No deformation and/or change	1A
12	60° (opposite direction)		No deformation and/or change	1A

* As specified by clause D.6 "Evaluation" of EN 13964:2014 standard

False ceiling with CELENIT AB 35 mm thick, ball impact resistant according to EN 13964/Attached D - DIN 18032/Part 3 standards

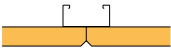
	Type of board	Structure	Certificate * No. / Date	Standard	Results
	CELENIT AB Thickness: 35 mm Dimensions: 1200x600 mm Edges: Chamfered - S4	C metal section 27x60x27 mm Distance between centers of cross joists: 600 mm Distance between centers of main joists: 900 mm Number of screws per board: 9	332602 31.03.2016	EN 13964	Class 1A
				DIN 18032-3	Visual examination Pass

* The certificate is based on tests carried out at the Giordano Institute (Bellaria - RN - Italy)

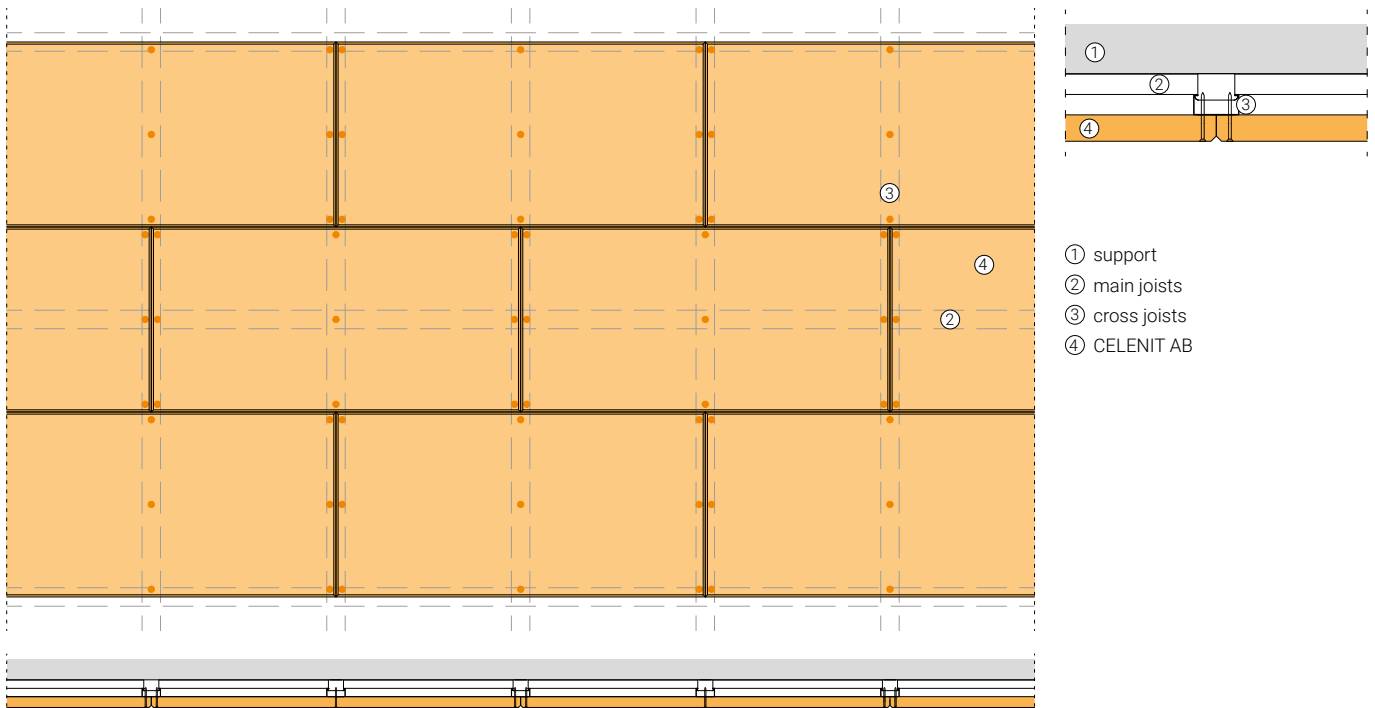

Description

CELENIT AB boards dimensions 1200x600 mm, 35 mm thick, with chamfered edges on 4 sides (code S4) with staggered laying on the short side. Boards are optionally painted and directly fixed to the cross joists made of C-shaped steel profile, section 60x27 mm and thickness 0.6 mm, placed orthogonally with a distance between centers of 600 mm. Cross joists

are supported by main joists made of C-shaped steel profile, section 60x27 mm and thickness 0.6 mm, placed orthogonally with a distance between centers of 900 mm. The boards are fixed on the underside to the cross joists using self-tapping screws, diameter 3.5 mm and spacing 300x600 mm (9 screws per board).

Classification: **CLASS 1A**

Test results

Impacts	Impact angle	Nominal velocity [m/s]	Visual examination *	Class
12	90°	16.5 ± 0.8	No deformation and/or change	1A
12	60°		No deformation and/or change	1A
12	60° (opposite direction)		No deformation and/or change	1A

* As specified by clause D.6 "Evaluation" of EN 13964:2014 standard

False ceiling with CELENIT AB/F 40 mm thick, EI60 fire resistance according to EN 13501-2:2009/Part 2 standard

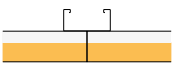
	Type of board	Structure	Certificate * No. / Date	Results
	CELENIT AB/F Thickness: 40 mm Dimensions: 1200x600 mm Edges: Straight - DT	C metal section 27x50x27 mm Distance between centers of cross joists: 400 mm Distance between centers of main joists: 600 mm Distance between centers of screws: 300 mm	312748/3620FR 23.01.2014	EI 60

* The certificate is based on tests carried out at the Giordano Institute (Bellaria - RN - Italy)

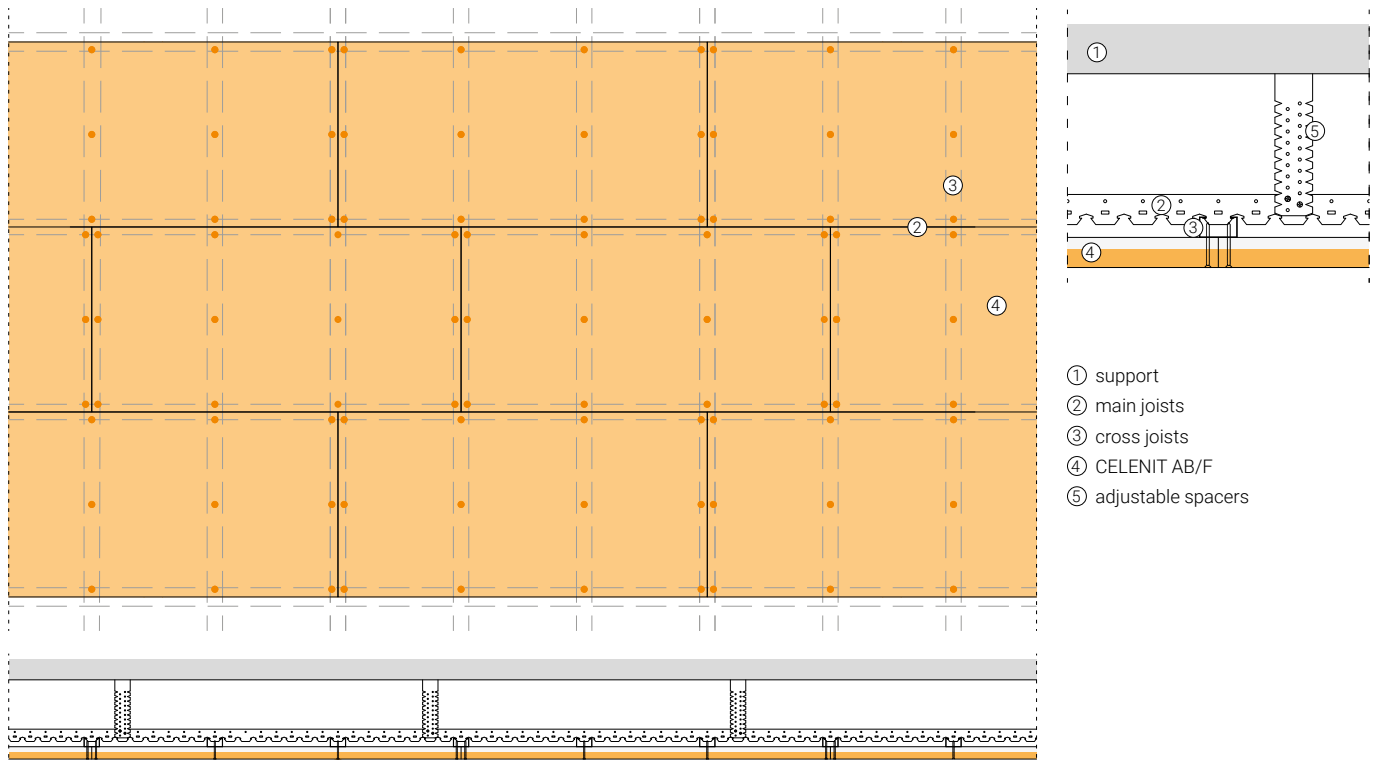

Description

The FALSE CEILING EI60 FIRE RESISTANT it's made of CELENIT AB/F, composite boards consisting of a layer of mineralized thin fir wood wool bound with white Portland cement coupled to a layer of fire rated plasterboard. Boards dimensions 1200x600 mm, 40 mm thick and optionally painted. Panels are directly fixed to the metal structure with staggered laying on the short side. The system consists of:

- longitudinal main joists made of galvanized steel profile which is U-shaped for the clic-in connection with the cross joists; section 40x28 mm, thickness 0.7 mm and length 3000 mm;

- cross joists made of galvanized C-shaped steel profile, section 27x50 mm and thickness 0.6 mm;
- perimetral frame made of galvanized C-shaped steel profile, section 30x27 mm and thickness 0.6 mm;
- adjustable spacers made of shaped steel.

Panels fixed to the secondary frame with fire-resistant glue and phosphated steel self-tapping screws.

Classification: **EI60**

Access panel

These instructions apply to the installation of the access panel in a C 60x27 mm profiles system.

CELENIT inspection system consists of the application of hatches made of CELENIT AB or CELENIT ABE boards, 25 mm thick, 1200x600 or 600x600 mm with beveled edges, specifically designed for installation on C60x27 profiles system.

CELENIT access panel are specially designed to create the maximum aesthetic continuity of the false ceiling, while maintaining the modular system and the chamfered edges completely hides the metal frame.

To open the acces panel there is a click-clack system. For 600x600 mm board there are two click-clack closures positioned at the end of the long side, for 1200x600 mm board there are 3 closures: two in the ends and one in the middle of the long side. Each access panel also has carabiners with a steel cable 10 cm long.



The photo refers to the back of the access panel

Inspection

1. Press at the ends of the long side of the panel to release click-clack closures and moove the unhooked internal panel downwards until the safety cables are taut.

2. Unhook the carabiner and gently accompany the inner panel.

3. Completely remove the inner panel, not leave it hanging precariously. Keep the inner board with care so as not to damage it.

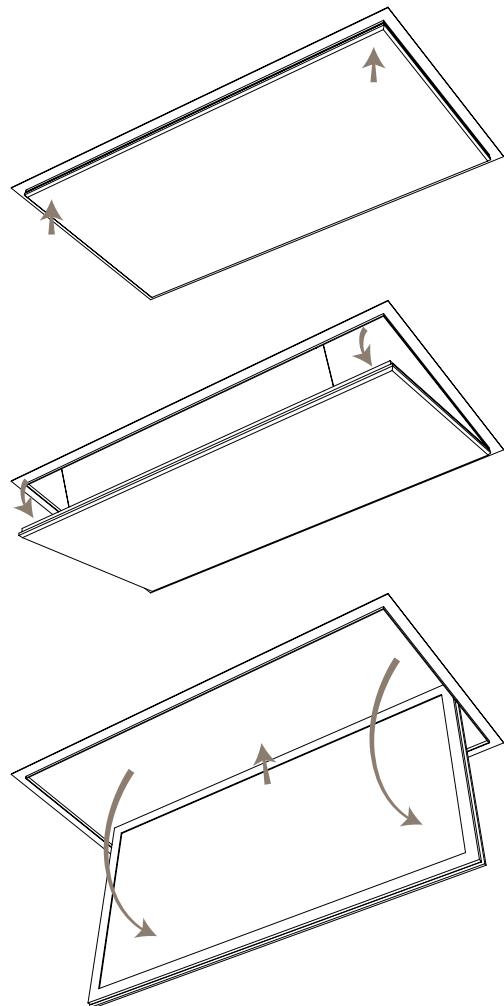

Installation system

Place primary profiles in such a way that in correspondence of the access panel are no profiles that prevent the inspection.

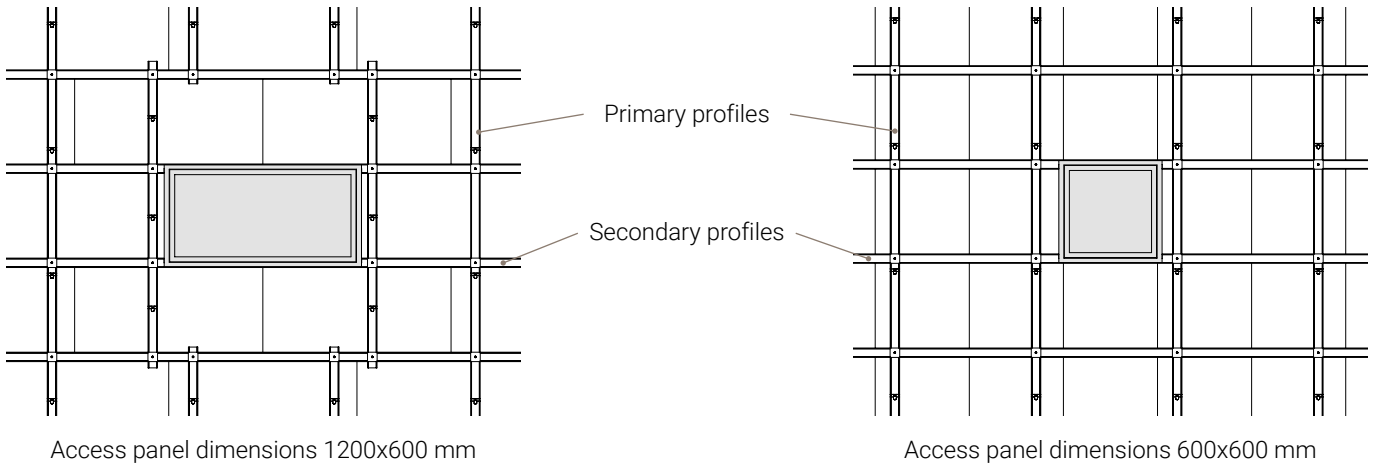

Access panel dimensions 1200x600 mm

Access panel dimensions 600x600 mm

Installation instructions

Suspended false ceiling with double C60x27 profiles system. Spacing between secondary profiles 60 cm.
 For more information see the installation instruction in the application data sheet of false ceilings with hidden metal structure.
 The boards will be fixed directly to the secondary C profiles with the long side parallel to profiles.

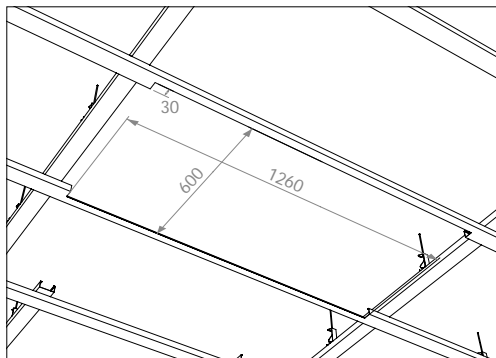

1. Partially cut the secondary profiles as shown to place the access panel structure.
 Dimensions of the cut: 1260x30 mm for access panel 1200x600 mm; 660x30 mm for access panel 600x600 mm.

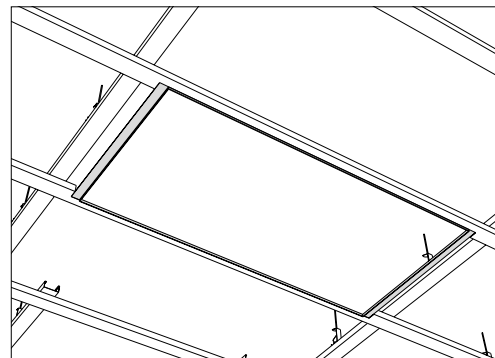

2. Lay the hatch structure between the two C60x27 profiles. Check that the internal frame of the access panel is perfectly "squared" with the secondary structure of the false ceiling, then fix it with selftapping steel screw.

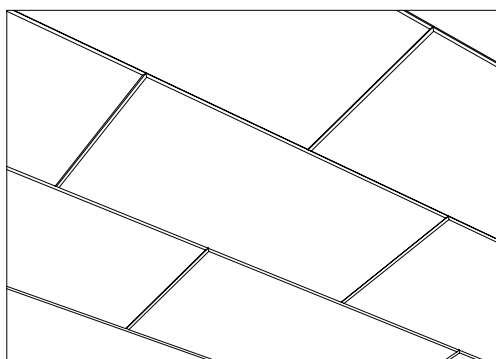

3. Install the false ceiling panels, paying close attention to the combination of the boards around the access panel.

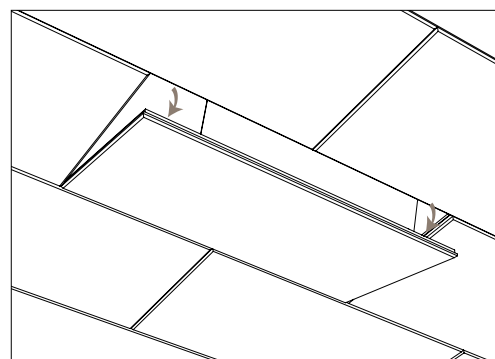

4. To open the access panel press at the ends of the long side of the panel to release click-clack closures.

Storage, use and maintenance

The boards must be stored on a pallet placed on a flat surface, protected from rain and direct sunlight. Pallets must be handled with care on site. Bumping the corners of the pallets can cause damage to the boards. For more information see the "Storage, use and maintenance" information (page 108) available in the download area of the website www.celenit.com.



CELENIT boards are dimensionally stable (EN 13168), however, they must be installed after acclimating to the same room they are going to be installed in, as well as after all concrete works are finished and the doors, windows, heating and ventilation systems have been installed.

Room temperature must be kept constant before and after installation. Do not suddenly change the temperature of the room after installation.

General installation instructions

- The boards have one side that should be visible (front of the board) and another side that should be placed against the structure (back of the board). The back of the board usually has the CELENIT logo or shows calibration marks. The front may be painted and/or has worked edges. In the absence of paint or edges, the front can be identified according to the pallet layout: the front of the boards faces the top and the back faces the pallet.
- With the aid of a laser level mark the positions for the fixings of the hangers (hangers, brackets or fixed spacer) and fix the elements.
- Design the secondary profiles position starting from the center of the ceiling to have a symmetric layout. The primary structure will be connected to the spacer elements by aligning them with a laser leveler.
- Fix the secondary structure to the primary (see page 32).
- If a vapour barrier is necessary, it'll install under the secondary profile with butyl double-sided adhesive tape. The tape also acts as a seal for the fixings of CELENIT boards.
- Fix the boards to the structure according to fixing schemes at page 31. Take maximum care while handling the panels. Corners and paint are easy to damage. Use clean gloves when installing the panels. Please find more information on stocking, use and maintenance (page 108) at www.celenit.com.
- We recommend boards with chamfered edges and staggered laying on the short side to ensure a nicer visual effect. The installation of boards with straight edge may be possible anyway.
- It is possible to insert mineral wool panels or wood fiber panels on top of CELENIT panels to improve acoustic and thermal performances while laying CELENIT boards.
- After the installation please follow the recommendations in the section "Storage, use and maintenance" (page 108) at www.celenit.com.

Important remarks

15 mm panels are not recommended for outdoor applications (with a roof protection) or in presence of high humidity.

CELENIT boards with DT edges code are not available because dimensions are not suitable for this system.



TINGLADO Pamplona, ES
design: Koa Arquitectura | photo: Koa Arquitectura

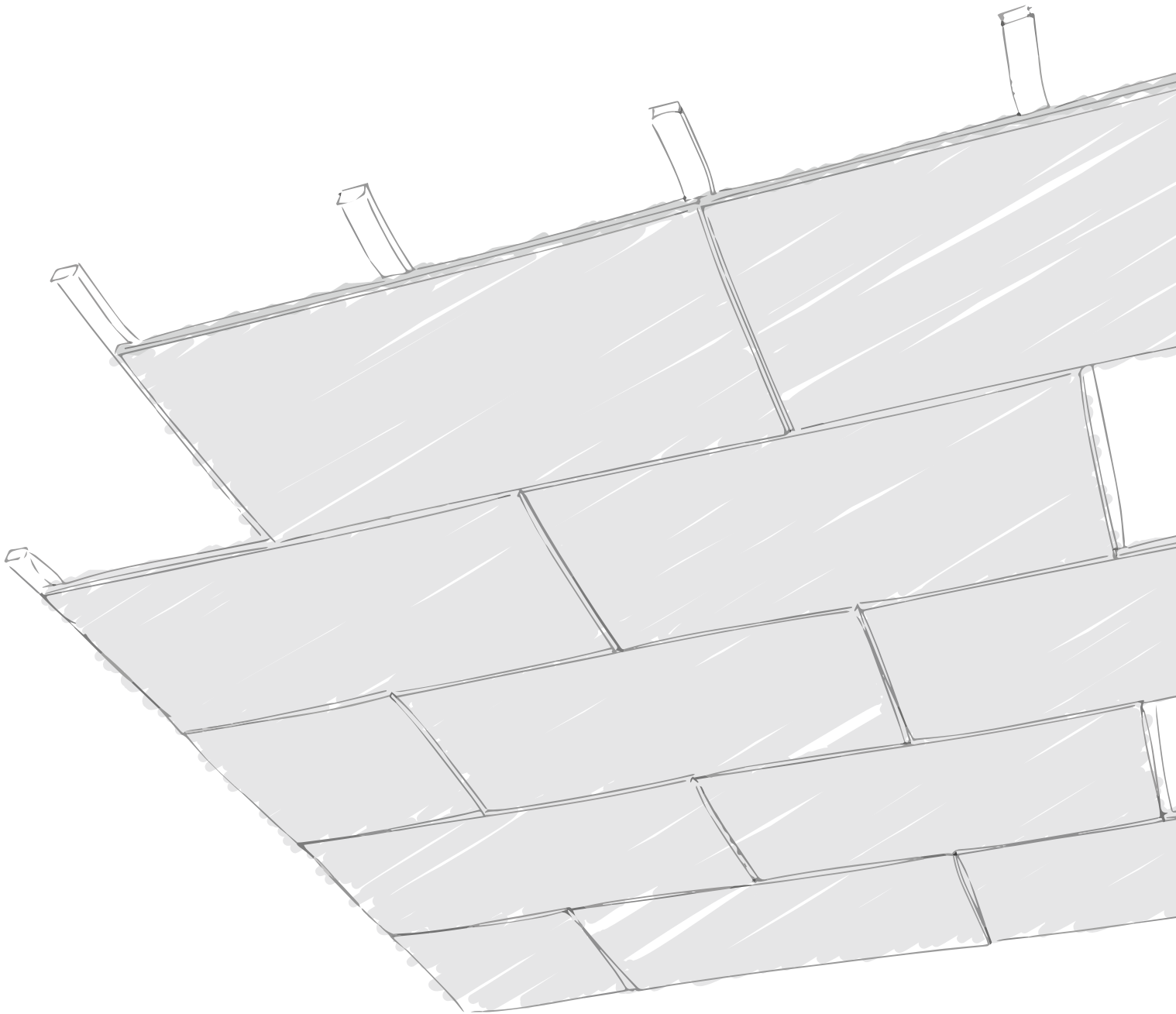

FALSE CEILINGS
**HIDDEN WOODEN
STRUCTURE**

Item specifications

CELENIT sound absorbing false ceiling with hidden wooden structure, model ACOUSTIC ..., with thermal and acoustic insulation, eco-friendly and sound absorbing boards - CELENIT ... product range, CELENIT ... item No. ... - made of mineralized ... fir wood wool bound with white Portland cement, it complies with EN 13168 and EN 13964 standards, it can be coupled with rock wool (ACOUSTIC MINERAL product range); dim.: ... x ... mm; th.: ... mm; texture: ...; straight edges (code: D) or chamfered edges (code: S4); weight: ... kg/m²; λ_D: ... W/mK; R_D: ... m²K/W; compressive stress σ₁₀: ≥ ... kPa; water vapour transmission μ: 5; reaction to fire: Euroclass B-s1, d0 or A2-s1, d0 (EN 13501-1 standard); sound absorption: α_w ... / NRC ...; durability: class C; light reflection:

50.7 o 74.0% (painted white 05/15); release of formaldehyde: class E1; it does not contain asbestos. Wood wool boards must be certified by ANAB-ICEA and natureplus for eco-compatibility of materials and manufacturing process, PEFC™ or FSC® for the sustainability of wood raw material, ICEA for the content of recycled material and for the attestation of LEED credits, EPD for the environmental statement. Wood laths dimensions ... x ... mm; spacing between primary laths: ... mm; spacing between secondary laths: ... mm; fixings per boards: ...; screws diameter: 3.5 mm; screws spacing: ... x ... mm.

Products



CELENIT ACOUSTIC range
ABE - AB

CELENIT ACOUSTIC A2 range
ABE/A2 - AB/A2

Boards made of mineralized wood wool bound with white Portland cement



Straight edges
D for all thicknesses



Chamfered edges
S4 for all thicknesses



Shiplap edges
RD10 for thicknesses 25 - 35 mm
RD20 for thicknesses 25 - 35 mm



CELENIT ACOUSTIC MINERAL range
L2ABE25 - L2AB25 - L2ABE25C

CELENIT ACOUSTIC MINERAL A2 range
L2ABE25/A2 - L2AB25/A2 - L2ABE25C/A2

Boards made of mineralized wood wool bound with white Portland cement coupled to a layer of rock wool



Straight edges
D for all thicknesses



Chamfered edges
S4 for all thicknesses

The boards are supplied with dimensions 1200x600 mm with rock wool 1200x500 mm, for direct application to the structure.

Except for **L2ABE25C** and **L2ABE25C/A2** which are supplied with rock wool 1200x600 mm and sufficient compression strength to avoid crushing during the laying. They can be screwed directly to the structure, either with orthogonal or parallel installation.

Single structure

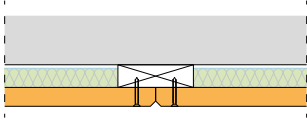

- System used to minimize the total lowering.
- Wood laths anchored to the ceiling with suitable fixings depending on the type of the support, or with adjustable brackets.
- Wood laths dimensions:
 - for CELENIT ACOUSTIC panels, recommended section (BxH) 60x40 mm or 80x40 mm
 - for CELENIT ACOUSTIC MINERAL panels, max. width 95 mm, min. height 30 mm
- Boards fixed directly to the wood laths according to the fixing schemes (page 46).

Double structure

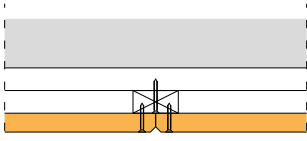

- The system is compatibles to false ceiling with ball-impact resistant certification with CELENIT ABE boards (page 7).
- Primary structure anchored to the ceiling with suitable fixings depending on the type of the support, or with lowering elements.
- Wood laths dimensions:
 - for CELENIT ACOUSTIC panels, recommended section (BxH) 60x40 mm or 80x40 mm
 - for CELENIT ACOUSTIC MINERAL panels, max. width 95 mm, min. height 30 mm
- Boards fixed directly to the wood laths according to the fixing schemes (page 46).

Orthogonal installation to the structure

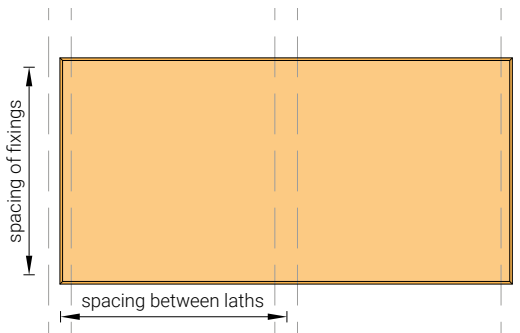

Only for CELENIT ACOUSTIC panels.

Board thickness [mm]	Dimensions [mm]	Spacing between laths [mm]
15	600x600	300
	1200x600	400
25 / 35	600x600	600
	1200x600	600
	2000x600	500
	2400x600	600

Parallel installation to the structure

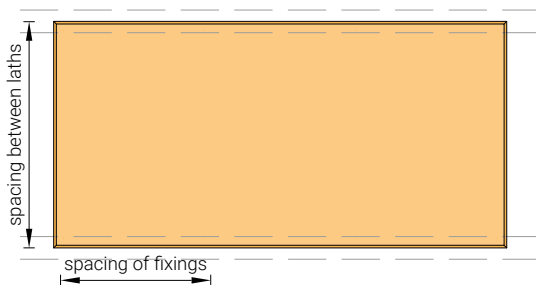

Available for CELENIT ACOUSTIC MINERAL boards or CELENIT ACOUSTIC boards.

Wood laths fixed every 600 mm (boards width).

Orthogonal installation to the structure

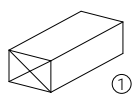
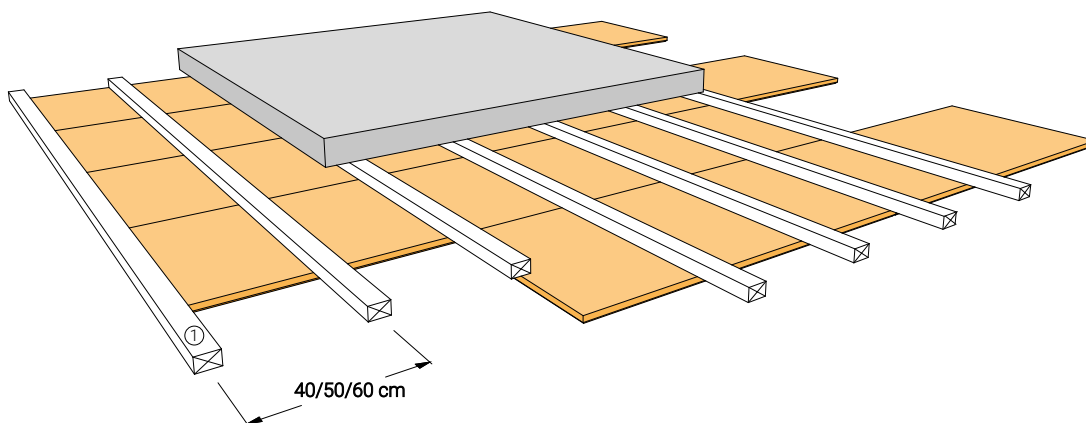
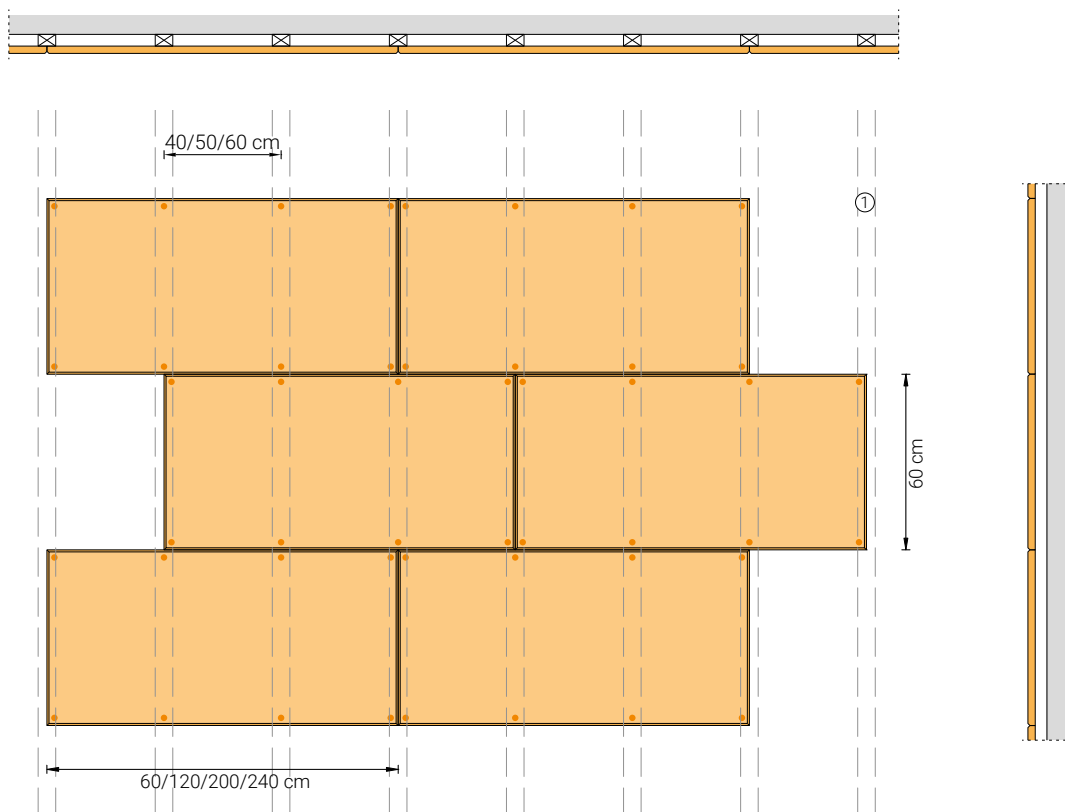

Wood laths
Recommended sections (BxH): 60x40 mm or 80x40 mm



Self-tapping screw for wood
White zinc-plated
Countersunk head with cross, fully threaded,
professional lubricant covering
Dimensions 4.5x35 - 4.5x45 - 4.5x60

Parallel installation to the structure

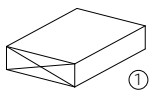
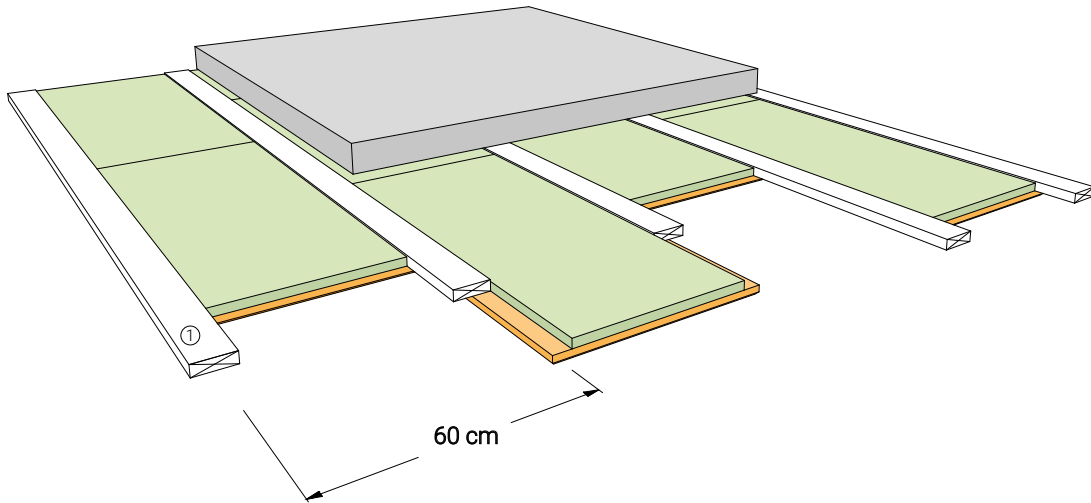
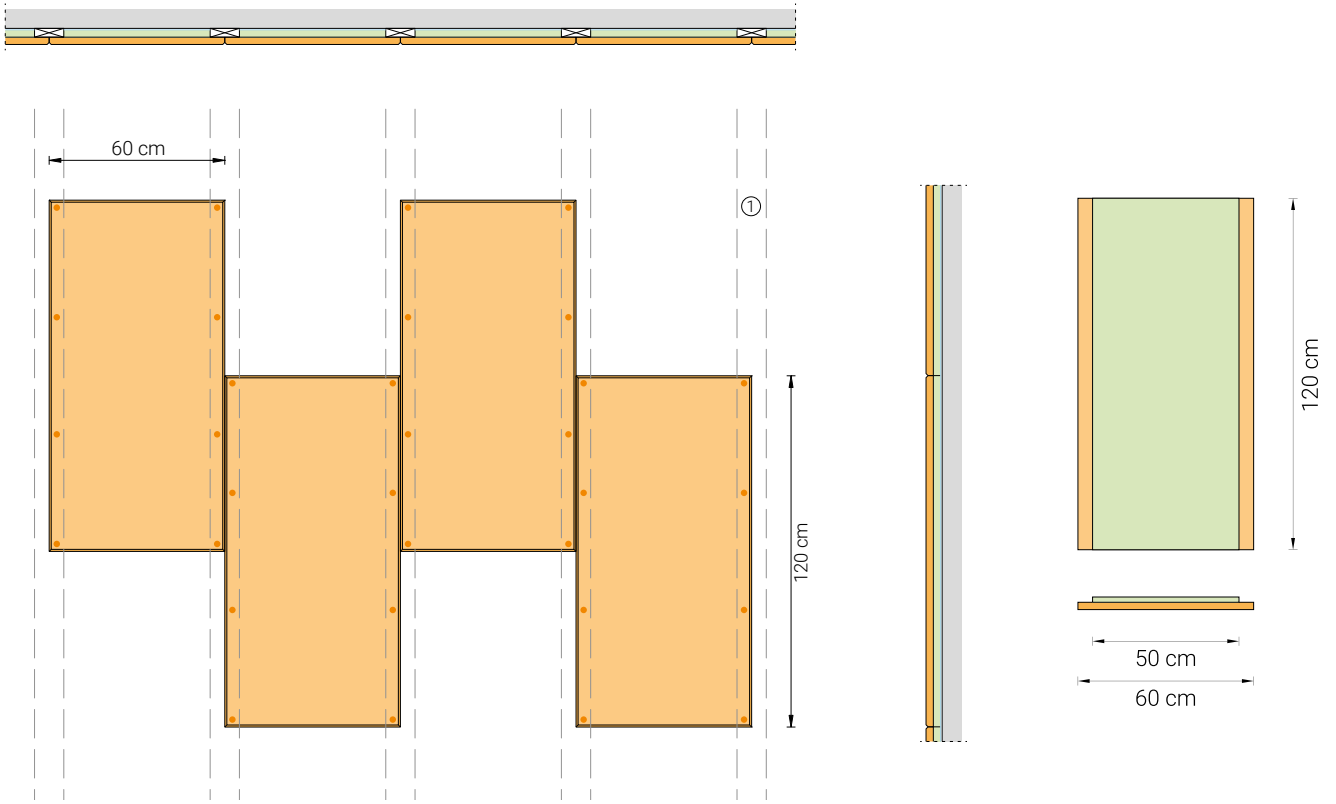

Wood laths
 Wood laths dimensions:
 • with CELENIT ACOUSTIC panels the recommended sections (BxH) are 60x40 mm or 80x40 mm
 • with CELENIT ACOUSTIC MINERAL panels, width max. 95 mm, height min. 30 mm



Self-tapping screw for wood
 White zinc-plated
 Countersunk head with cross, fully threaded, professional lubricant covering
 Dimensions 4.5x35 - 4.5x45 - 4.5x60

Fixings schemes

CELENIT ACOUSTIC range

• thickness 15 mm

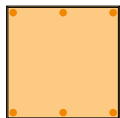

600x600 mm - 6 screws
Orthogonal installation:
Spacing of fixings 600 mm
Wood laths fixed every 300 mm

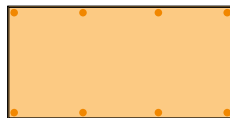

1200x600 mm - 8 screws
Orthogonal installation:
Spacing of fixings 600 mm
Wood laths fixed every 400 mm

• thicknesses 25/35 mm

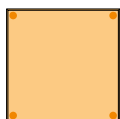

600x600 mm - 4 screws
Orthogonal/parallel installation:
Spacing of fixings 600 mm
Wood laths fixed every 600 mm



2000x600 mm - 10 screws
Parallel installation:
Spacing of fixings 500 mm
Wood laths fixed every 600 mm
Orthogonal installation:
Spacing of fixings 600 mm
Wood laths fixed every 500 mm

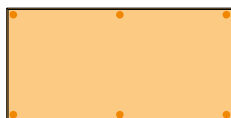

1200x600 mm - 6 screws
Parallel installation:
Spacing of fixings 600 mm
Wood laths fixed every 600 mm
Orthogonal installation:
Spacing of fixings 600 mm
Wood laths fixed every 600 mm



2400x600 mm - 10 screws
Orthogonal/parallel installation:
Spacing of fixings 600 mm
Wood laths fixed every 600 mm

Board thickness [mm]	Dimensions [mm]	Screws per board [No.]	Screws per m ² [No./m ²]	Screw dimensions [mm]
15	600x600	6	16.7	4.5x35
	1200x600	8	11.2	
25	600x600	4	11.2	4.5x45
	1200x600	6	8.4	
	2000x600	10	8.4	
	2400x600	10	7.0	
35	600x600	4	11.2	4.5x60
	1200x600	6	8.4	
	2000x600	10	8.4	
	2400x600	10	7.0	

CELENIT ACOUSTIC MINERAL range

• wood wool thickness 25 mm

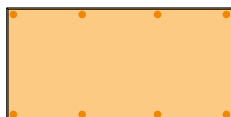

1200x600 mm - 8 screws
Parallel installation:
Spacing of fixings 400 mm
Wood laths fixed every 600 mm

Wood wool board thickness [mm]	Dimensions [mm]	Screws per board [No.]	Screws per m ² [No./m ²]	Screw dimensions [mm]
25	1200x600	8	11.2	4.5x45

False ceiling with CELENIT ABE 25 mm thick, **ball impact resistant** according to EN 13964/Attached D - DIN 18032/Part 3 standards

	Type of board	Structure	Certificate * No. / Date	Standard	Results
	CELENIT ABE Thickness: 25 mm Dimensions: 1200x600 mm Edges: Chamfered - S4	Wooden battens size 60x30 mm Distance between centers of cross laths: 600 mm Distance between centers of main laths: 900 mm Number of screws per board: 9	332600 31.03.2016	EN 13964	Class 1A
				DIN 18032-3	Visual examination Pass

* The certificate is based on tests carried out at the Giordano Institute (Bellaria - RN - Italy)

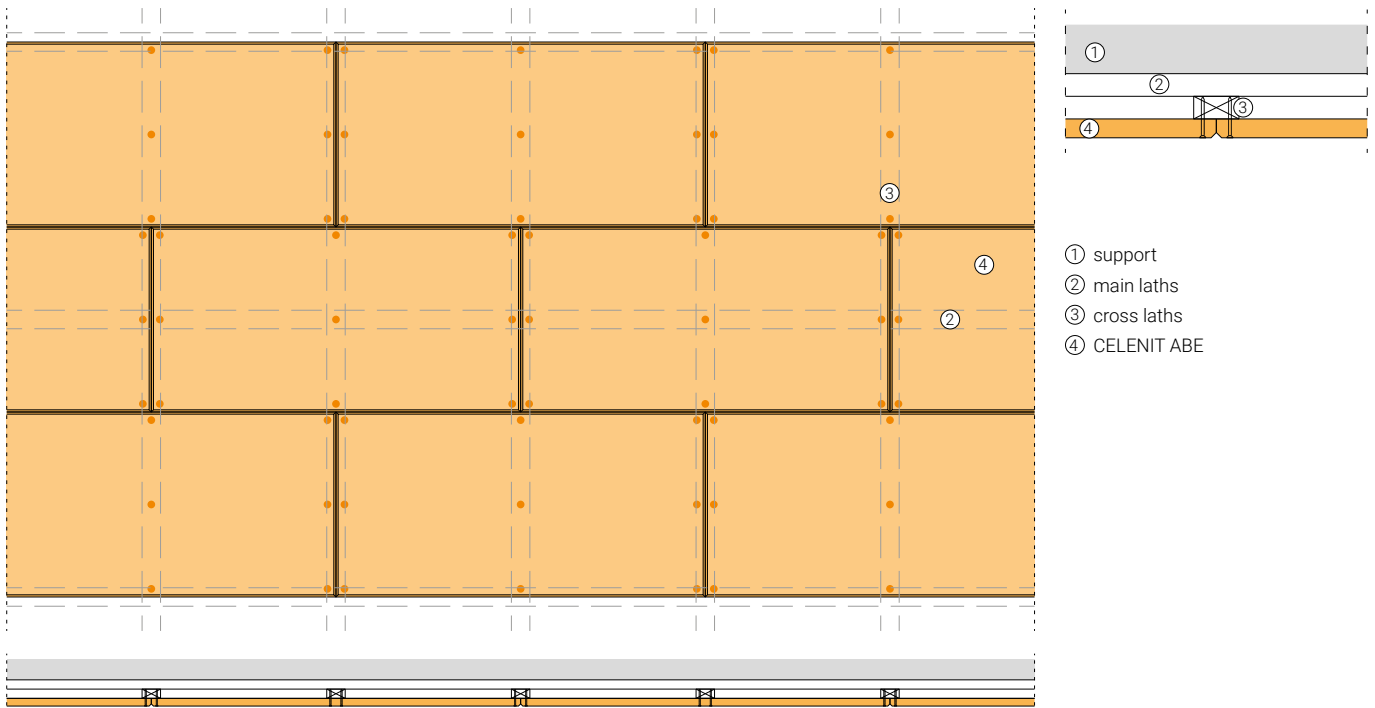

Description

CELENIT ABE boards dimensions 1200x600 mm, 25 mm thick, with chamfered edges on 4 sides (code S4) with staggered laying on the short side. Boards are optionally painted and directly fixed to the cross wood laths, section 60x30 mm, placed orthogonally with a distance between centers of 600 mm. Cross wood laths are supported by main wood laths,

section 60x30 mm, placed orthogonally with a distance between centers of 900 mm. The boards are fixed on the underside to the cross wood laths using self-tapping screws, diameter 3.5 mm and spacing 300x600 mm (9 screws per board).

Classification: **CLASS 1A**

Test results

Impacts	Impact angle	Nominal velocity [m/s]	Visual examination *	Class
12	90°	16.5 ± 0.8	No deformation and/or change	1A
12	60°		No deformation and/or change	1A
12	60° (opposite direction)		No deformation and/or change	1A

* As specified by clause D.6 "Evaluation" of EN 13964:2014 standard

Storage, use and maintenance

The boards must be stored on a pallet placed on a flat surface, protected from rain and direct sunlight. Pallets must be handled with care on site. Bumping the corners of the pallets can cause damage to the boards. For more information see the "Storage, use and maintenance" information (page 108) available in the download area of the website www.celenit.com.



CELENIT boards are dimensionally stable (EN 13168), however, they must be installed after acclimating to the same room they are going to be installed in, as well as after all concrete works are finished and the doors, windows, heating and ventilation systems have been installed.

Room temperature must be kept constant before and after installation. Do not suddenly change the temperature of the room after installation.

General installation instructions

- The boards have one side that should be visible (front of the board) and another side that should be placed against the structure (back of the board). The back of the board usually has the CELENIT logo or shows calibration marks. The front may be painted and/or has worked edges. In the absence of paint or edges, the front can be identified according to the pallet layout: the front of the boards faces the top and the back faces the pallet.
- Fix the bearing laths starting from the center of the ceiling to have a symmetric layout. Wood laths will be fixed directly to the ceiling with suitable screw or louvered with adjustable brackets. With the aid of a laser level fix the wood laths to the brackets with no. 2 screws per side.
- Fix the secondary structure to the primary with no. 2 screws per intersection.
- If a vapour barrier is necessary, it'll install under the secondary profile with butyl double-sided adhesive tape. The tape also acts as a seal for the fixings of CELENIT boards.

- Fix the boards to the structure according to fixing schemes at page 46. Take maximum care while handling the panels. Corners and paint are easy to damage. Use clean gloves when installing the panels. Please find more information on stocking, use and maintenance (page 108) at www.celenit.com.
- We recommend to fix the screws the screws to the wood laths with an inclination of about 5°-6° to give more tightness to the screws on the support.
- We recommend boards with chamfered edges and staggered laying on the short side to ensure a nicer visual effect. The installation of boards with straight edge may be possible anyway.
- It is possible to insert mineral wool panels or wood fiber panels on top of CELENIT panels to improve acoustic and thermal performances while laying CELENIT boards.
- After the installation please follow the recommendations in the section "Storage, use and maintenance" (page 108) at www.celenit.com.

Important remarks

15 mm panels are not recommended for outdoor applications (with a roof protection) or in presence of high humidity.

CELENIT boards with DT edges code are not available because dimensions are not suitable for this system.



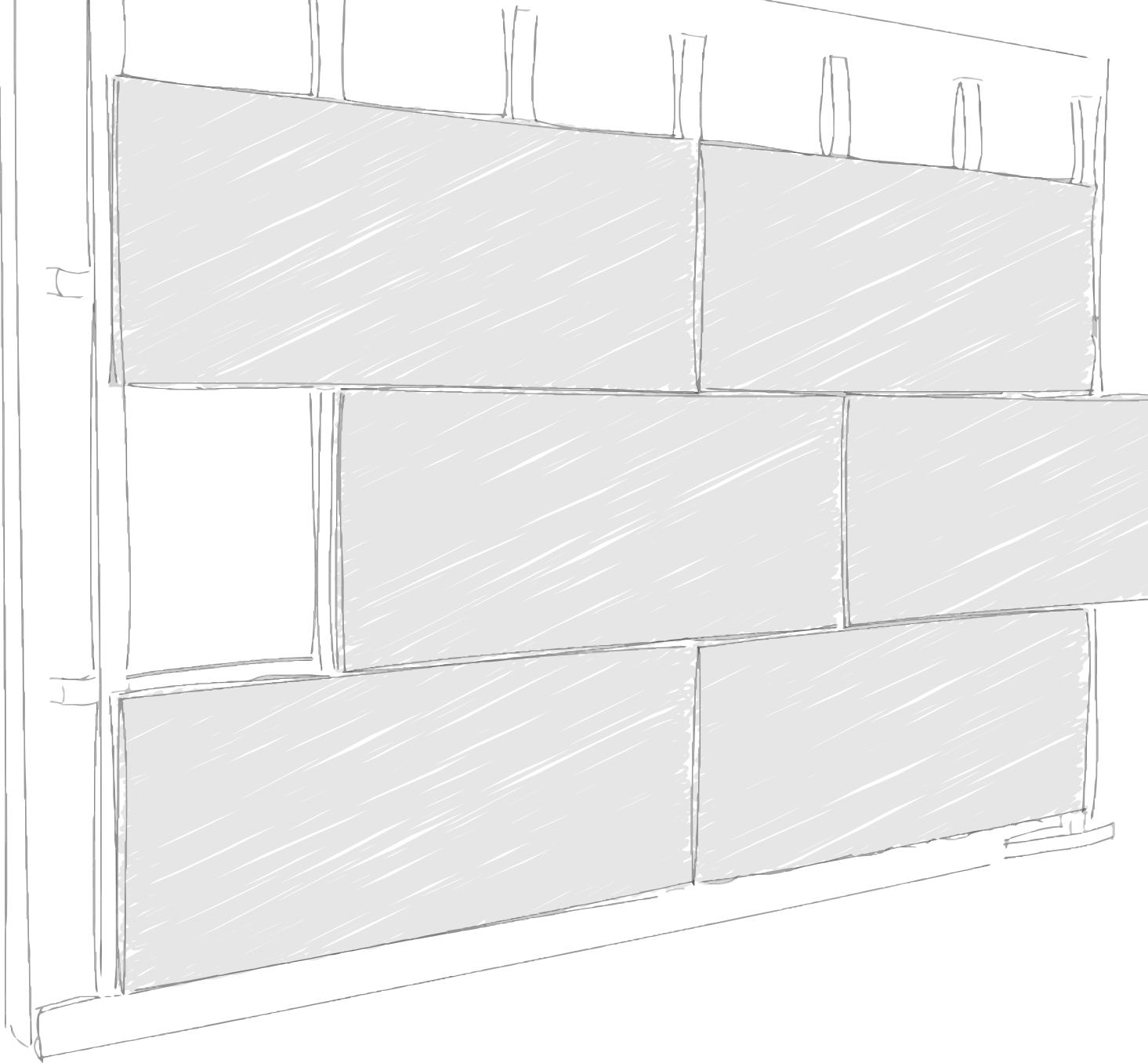

WALL COVERINGS
**HIDDEN METAL
STRUCTURE**

Item specifications

CELENIT sound absorbing wall covering with hidden metal structure, model ACOUSTIC ..., with thermal and acoustic insulation, eco-friendly and sound absorbing boards - CELENIT ... product range, CELENIT ... item No. ... - made of mineralized ... fir wood wool bound with white Portland cement, it complies with EN 13168 and EN 13964 standards, it can be coupled with rock wool (ACOUSTIC MINERAL product range); dim.: ... x ... mm; th.: ... mm; texture: ...; straight edges (code: D) or chamfered edges (code: S4); weight: ... kg/m²; λ_D : ... W/mK; R_D : ... m²K/W; compressive stress σ_{10} : \geq ... kPa; water vapour transmission μ : 5; reaction to fire: Euroclass B-s1, d0 or A2-s1, d0 (EN 13501-1 standard); sound absorption: α_w ... / NRC ...; durability: class C; light reflection: 50.7 o 74.0% (painted white 05/15); release of formaldehyde: class E1; it does not contain asbestos.

Wood wool boards must be certified by ANAB-ICEA and natureplus for eco-compatibility of materials and manufacturing process, PEFC™ or FSC® for the sustainability of wood raw material, ICEA for the content of recycled material and for the attestation of LEED credits, EPD for the environmental statement.

C profiles 60x27 or C 50x27 with ... mm spacing, suspended by fixed spacers/adjustable brackets or supported by clip profiles/C profiles, suspended by hangers. Fixings per boards: ...; screws diameter: 3.5 mm; fixings scheme: ... x ... mm.

Products



CELENIT ACOUSTIC range
ABE - AB

CELENIT ACOUSTIC A2 range
ABE/A2 - AB/A2

Boards made of mineralized wood wool bound with white Portland cement



Straight edges
D for all thicknesses



Chamfered edges
S4 for all thicknesses



Shiplap edges
RD10 for thicknesses 25 - 35 mm
RD20 for thicknesses 25 - 35 mm



CELENIT ACOUSTIC MINERAL range
L2ABE25 - L2AB25 - L2ABE25C

CELENIT ACOUSTIC MINERAL A2 range
L2ABE25/A2 - L2AB25/A2 - L2ABE25C/A2

Boards made of mineralized wood wool bound with white Portland cement coupled to a layer of rock wool



Straight edges
D for all thicknesses



Chamfered edges
S4 for all thicknesses

The boards are supplied with dimensions 1200x600 mm with rock wool 1200x500 mm, for direct application to the structure.

Except for **L2ABE25C** and **L2ABE25C/A2** which are supplied with rock wool 1200x600 mm and sufficient compression strength to avoid crushing during the laying. They can be screwed directly to the structure, either with orthogonal or parallel installation.

Single structure

Available for CELENIT ACOUSTIC boards or CELENIT ACOUSTIC MINERAL boards with rock wool thickness until 40 mm.

System with fixed spacer

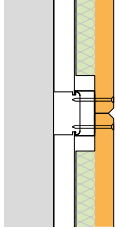

- The system with fixed spacer allows to have a single structure.
- Spacers anchored to the wall with suitable fixings depending on the type of the support.
- Maximum distance between spacers 80 cm.
- The boards will be fixed directly to the C profiles according to the fixing schemes (page 59).

System with adjustable bracket

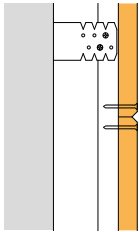

- The system with adjustable bracket allows to have a single structure.
- The bracket allows adjustable air-gap.
- Spacers anchored to the wall with suitable fixings depending on the type of the support.
- Maximum distance between bracket 80 cm.
- The boards will be fixed directly to the C profiles according to the fixing schemes (page 59).

Double structure

Available for CELENIT ACOUSTIC boards or CELENIT ACOUSTIC MINERAL boards with rock wool thickness 18 - 25 mm.

System with clip steel profile

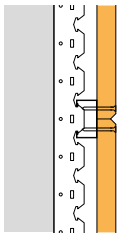

- Clip steel profile anchored to the wall with suitable fixings depending on the type of the support.
- C profiles fixed on clip steel profile, with a maximum distance of 60 cm.
- The boards will be fixed directly to the C profiles according to the fixing schemes (page 59).

System with double C profiles

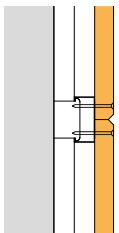

- Fixed spacer anchored to the wall with suitable fixings depending on the type of the support.
- Secondary C profiles with a maximum distance of 60 cm, fixed to the primary C profiles with a clip hook.
- The boards will be fixed directly to the C profiles according to the fixing schemes (page 59).

The profiles can be anticorrosion treated on demand for high relative humidity applications: swimming pools, saunas, kitchens, changing rooms of gym and health centers.

Orthogonal installation to the structure

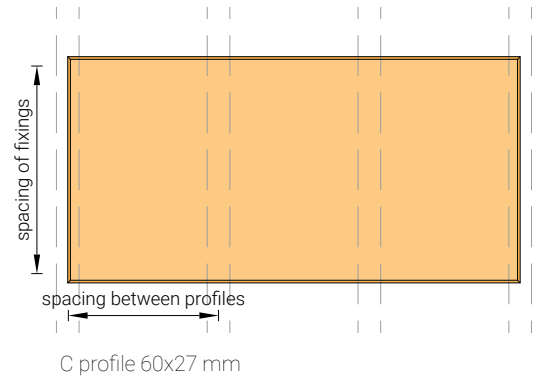
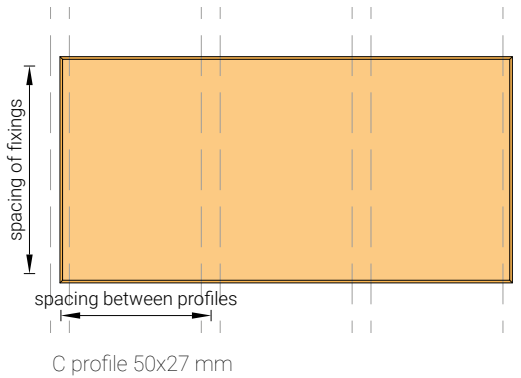

Only for CELENIT ACOUSTIC panels

- Secondary C profile fixed according to panel length. Generally C profile are fixed every 400 mm or 600 mm; for boards length 2000 mm C profiles can be fixed every 500 mm.
- Secondary C profile dimensions 50x27x0.6 mm; also available section 60x27 mm.

- C profile will be mounted vertically
- System anchored to the ceiling with suitable fixings depending on the type of the support.

Parallel installation to the structure

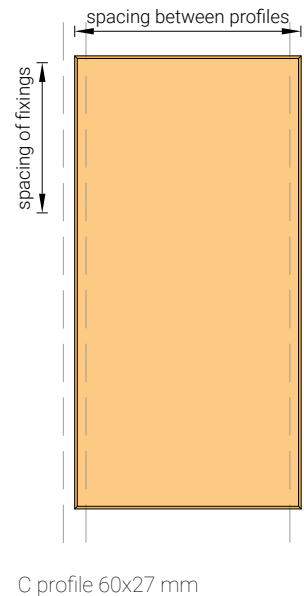
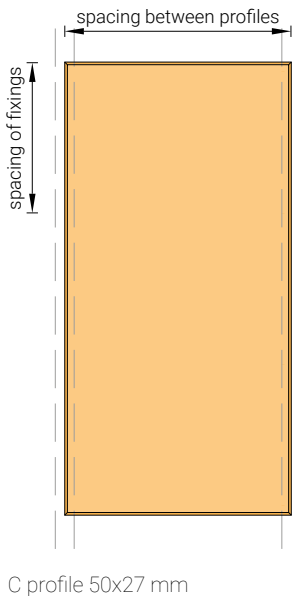

Available for CELENIT ACOUSTIC MINERAL boards or CELENIT ACOUSTIC boards

- System generally used for adhered application, to containing the total thickness.
- C profile fixed every 600 mm.
- C profile dimensions 50x27x0.6 mm; also available section 60x27 mm.

- C profile will be mounted vertically
- System anchored to the ceiling with suitable fixings depending on the type of the support.

Single structure with fixed spacers and C profiles

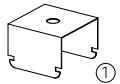
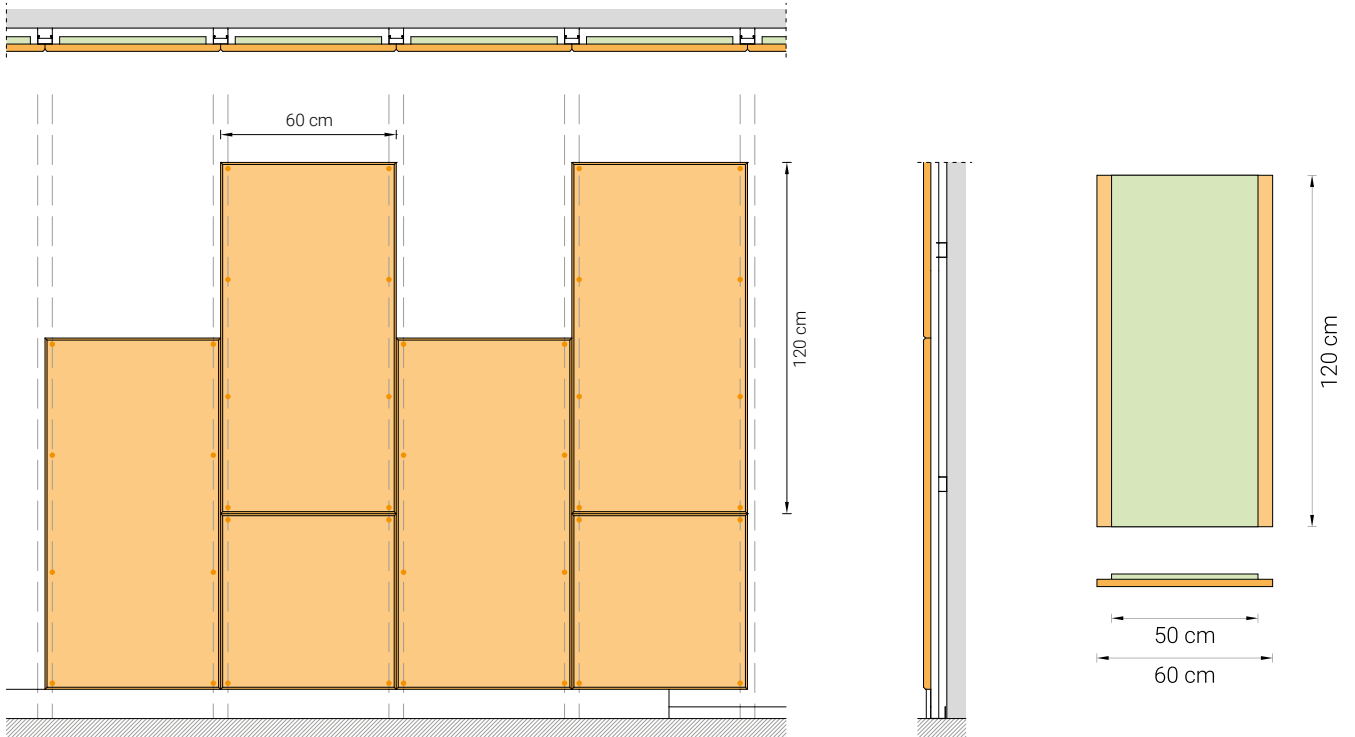

Galvanized steel fixed spacer for C profile
Dimensions 50x30 mm or 60x30 mm,
rounded edge

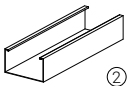

Galvanized steel C profile
Dimensions 27x50x27 mm or 27x60x27 mm,
thickness 0.6 mm, rounded edge

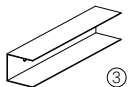

U-shaped perimeter guide
Dimensions 28x30x28 mm
Thickness 0.6 mm



Selftapping steel screw for plasterboard
Countersunk head
Dimensions 3.5x35 - 3.5x45 - 3.5x55 mm

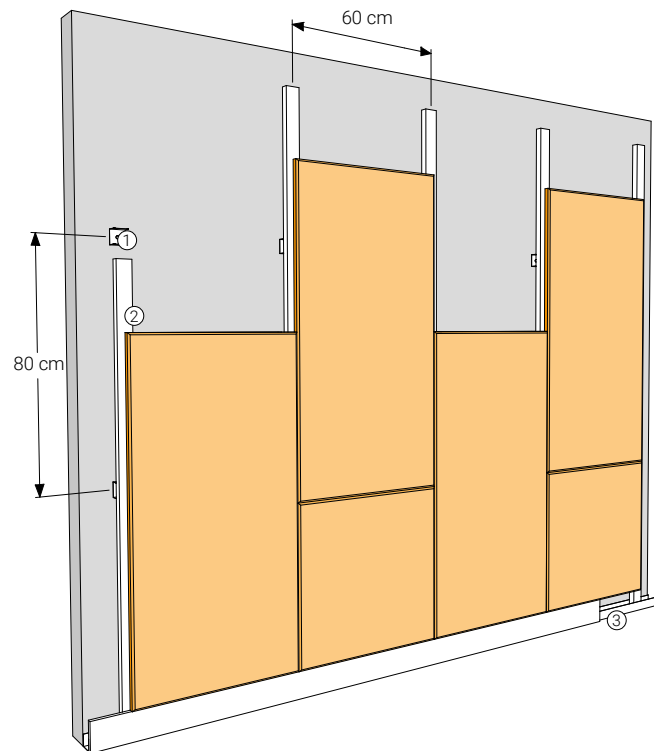

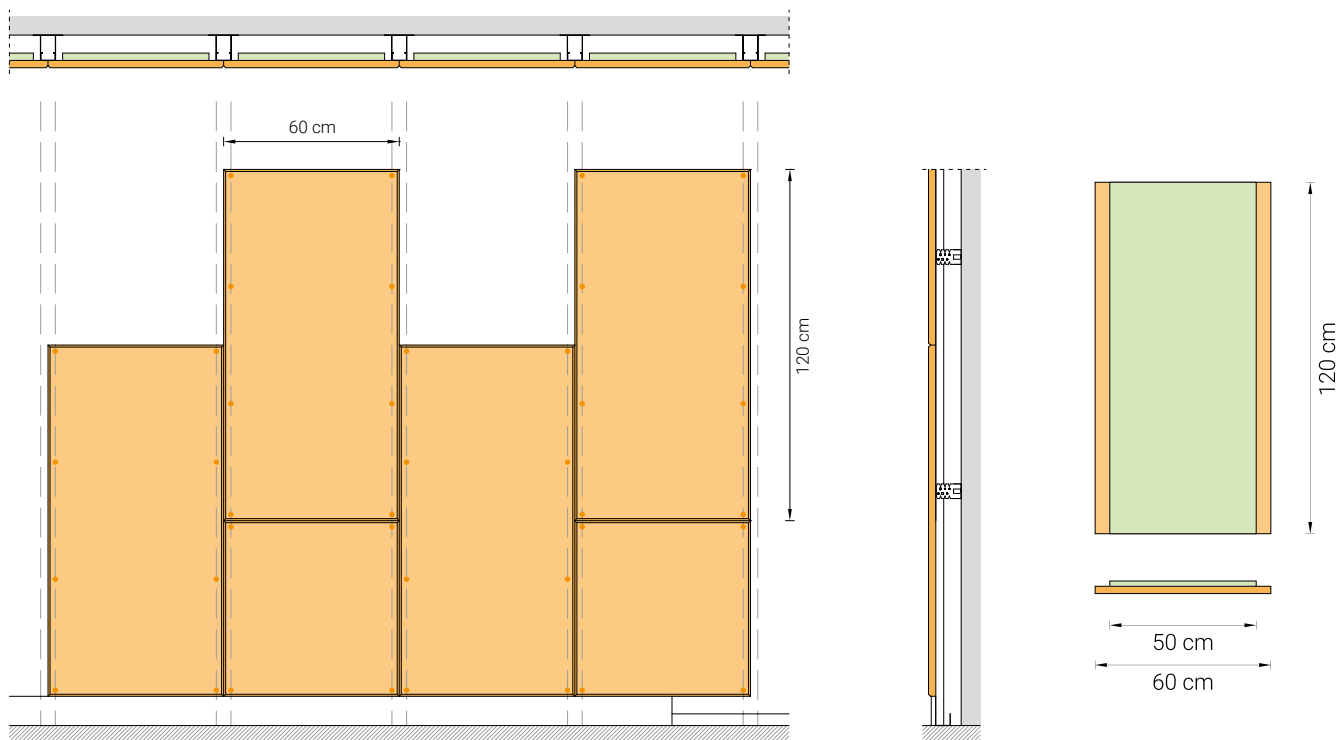

Single structure with adjustable brackets and C profiles

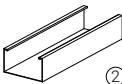

- 

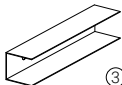
① Adjustable steel bracket for C profile
Width 50 mm or 60 mm
- 

② Galvanized steel C profile
Dimensions 27x50x27 mm or 27x60x27 mm,
thickness 0.6 mm, rounded edge
- 

③ U-shaped perimeter guide
Dimensions 28x30x28 mm
Thickness 0.6 mm
- 

Selftapping steel screw for plasterboard
Countersunk head
Dimensions 3.5x35 - 3.5x45 - 3.5x55 mm

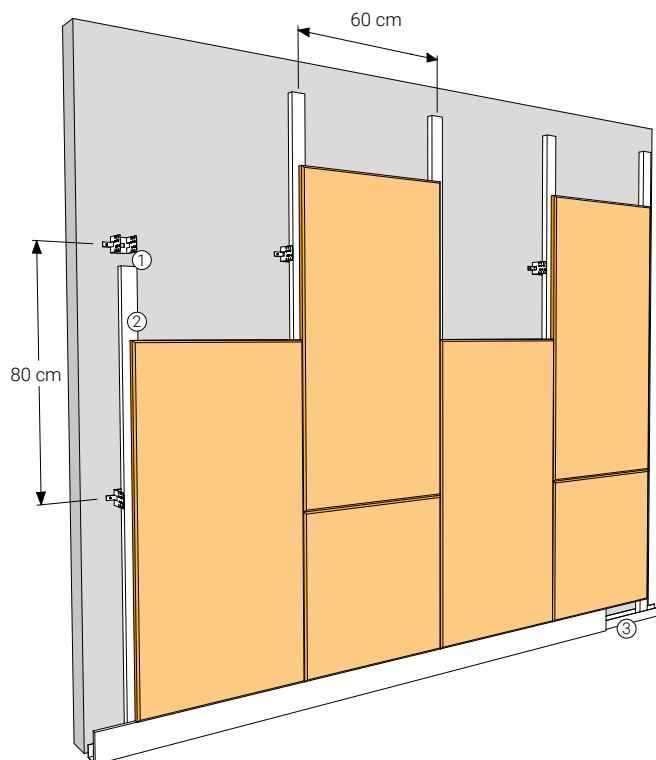

Double structure with clip steel profiles and C profiles

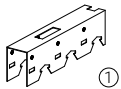
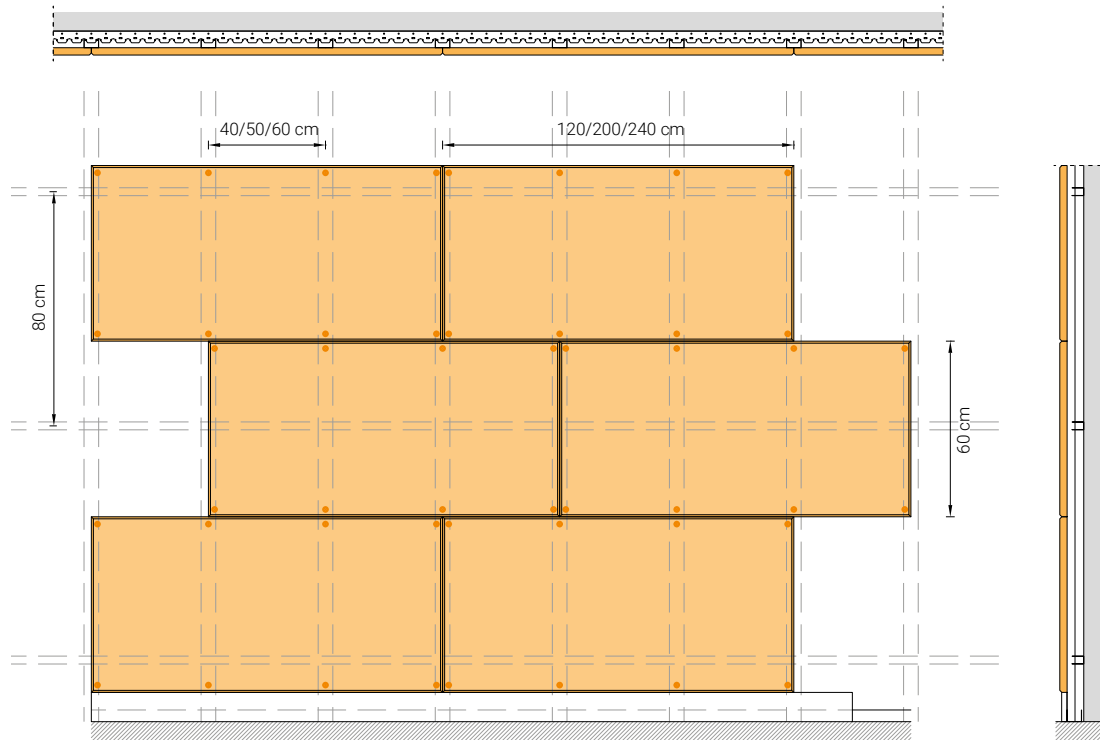

Primary galvanized steel clip profile for C profile
Dimensions 43x28 mm,
thickness 0.6 mm, rounded edge

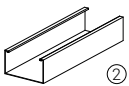

Galvanized steel C profile
Dimensions 27x50x27 mm or 27x60x27 mm,
thickness 0.6 mm, rounded edge

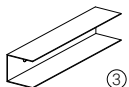

U-shaped perimeter guide
Dimensions 28x30x28 mm
Thickness 0.6 mm



Selftapping steel screw for plasterboard
Countersunk head
Dimensions 3.5x35 - 3.5x45 - 3.5x55 mm

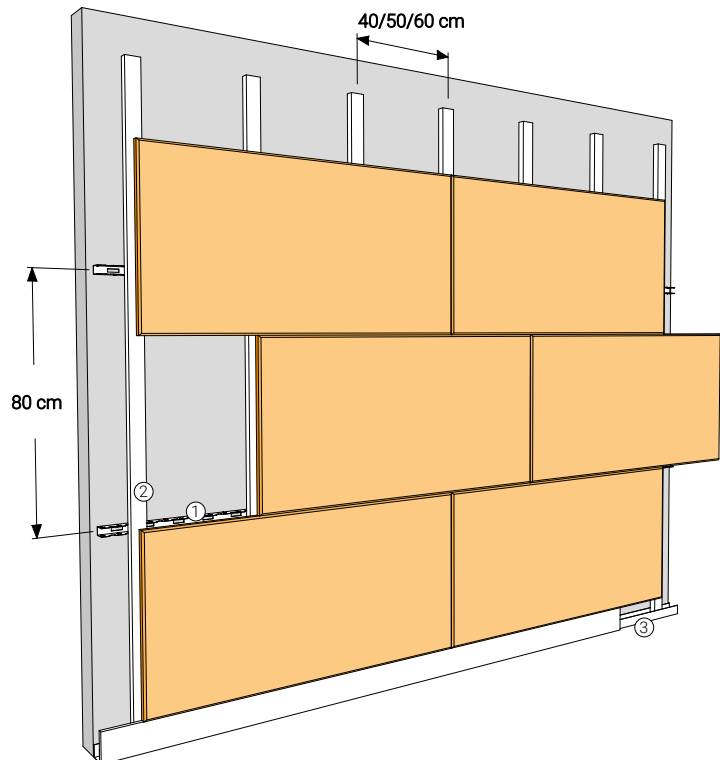

Double structure with double C profiles

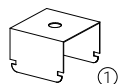
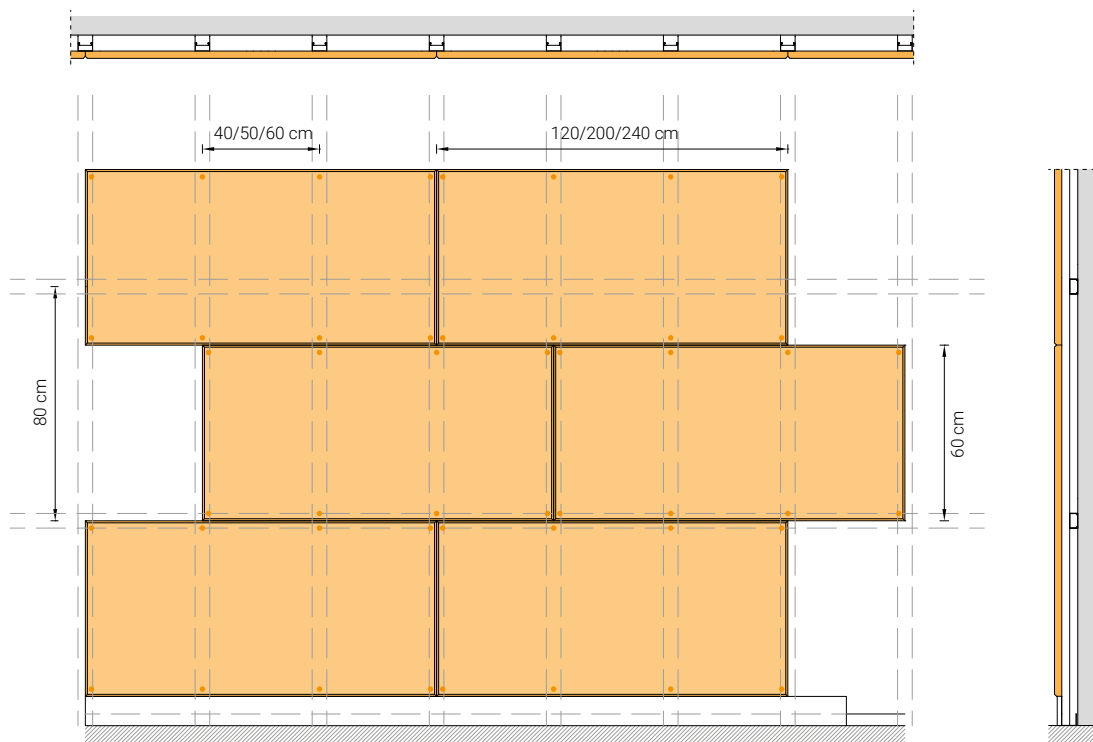

Galvanized steel fixed spacer for C profile
Dimensions 50x30 mm or 60x30 mm,
rounded edge

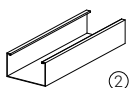

Galvanized steel C profile
Dimensions 27x50x27 mm or 27x60x27 mm,
thickness 0.6 mm, rounded edge

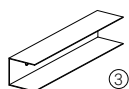

U-shaped perimeter guide
Dimensions 28x30x28 mm
Thickness 0.6 mm



Selftapping steel screw for plasterboard
Countersunk head
Dimensions 3.5x35 - 3.5x45 - 3.5x55 mm

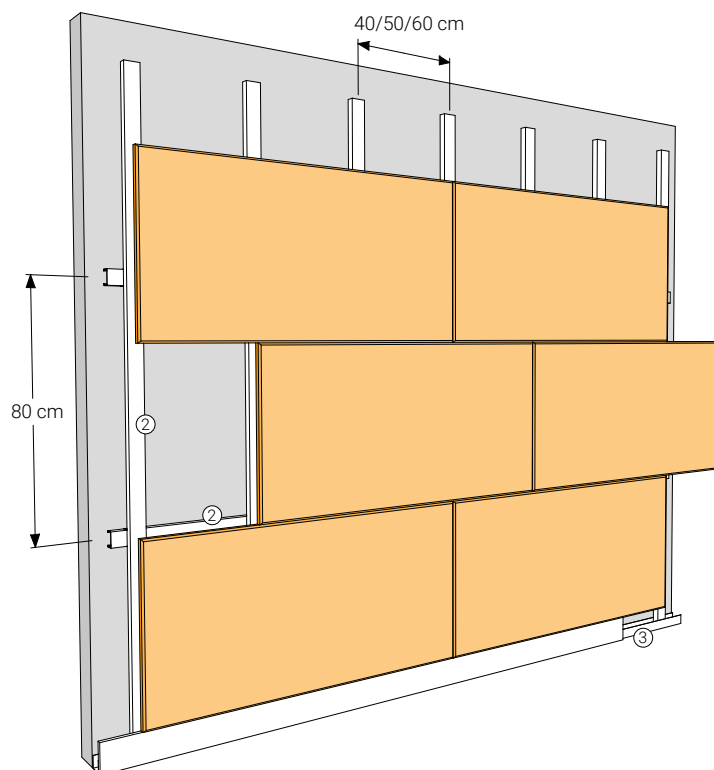

C 27x60x27 profiles must be used for wall coverings ball-impact resistant by adjusting the size of the fixed spacers and the hangers (see pages 61-62).

Fixings schemes

CELENIT ACOUSTIC range

• thickness 15 mm

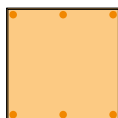

600x600 mm - 6 screws
Orthogonal installation:
Spacing of fixings 600 mm
C profile fixed every 300 mm



1200x600 mm - 8 screws
Orthogonal installation:
Spacing of fixings 600 mm
C profile fixed every 400 mm

• thicknesses 25/35 mm

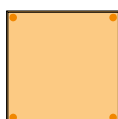

600x600 mm - 4 screws
Orthogonal/parallel installation:
Spacing of fixings 600 mm
C profile fixed every 600 mm



2000x600 mm - 10 screws
Parallel installation:
Spacing of fixings 500 mm
C profile fixed every 600 mm
Orthogonal installation:
Spacing of fixings 600 mm
C profile fixed every 500 mm



1200x600 mm - 8 screws
Parallel installation:
Spacing of fixings 400 mm
C profile fixed every 600 mm
Orthogonal installation:
Spacing of fixings 600 mm
C profile fixed every 400 mm



2400x600 mm - 10 screws
Orthogonal/parallel installation:
Spacing of fixings 600 mm
C profile fixed every 600 mm

Board thickness [mm]	Dimensions [mm]	Screws per board [No.]	Screws per m ² [No./m ²]	Spacing between profile [mm]	Screw dimensions [mm]
15	600x600	6	16.7	300	3.5x35
	1200x600	8	11.2	400	
25	600x600	4	11.2	600	3.5x45
	1200x600	8	11.2	400 *	
	2000x600	10	8.4	500	
35	2400x600	10	7.0	600	3.5x55
	600x600	4	11.2	600	
	1200x600	8	11.2	400 *	
	2000x600	10	8.4	500	
	2400x600	10	7.0	600	

* C profile every 600 mm are also available, with screws spacing 300 mm and 9 screws per board (12.5 fixings/m²)

CELENIT ACOUSTIC MINERAL range

• wood wool thickness 25 mm



1200x600 mm - 8 screws
Parallel installation:
Spacing of fixings 400 mm
C profile fixed every 600 mm

Wood wool board thickness [mm]	Dimensions [mm]	Screws per board [No.]	Screws per m ² [No./m ²]	Spacing between profile [mm]	Screw dimensions [mm]
25	1200x600	8	11.2	600	3.5x45

Indicative quantities

Application with fixed spacers and C profiles

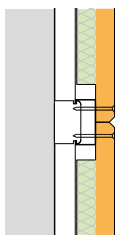

Type	Section [mm]	Length [mm]	Spacing [mm]	Indicative quantities
Galvanized steel fixed spacer for C profile	50x30 (30x60)	-	800 * ¹	2.10 pcs/m ² C profiles every 600 mm
				2.50 pcs/m ² C profiles every 500 mm
				3.10 pcs/m ² C profiles every 400 mm
C profile	27x50x27 (27x60x27)	3000/4000	600	1.70 m/m ²
			500	2.00 m/m ²
			400	2.30 m/m ²
U-shaped perimeter guide	28x30x28	3000/4000	-	Perimeter * ²

Application with adjustable brackets and C profiles

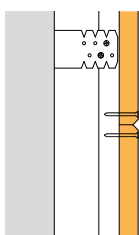

Type	Section [mm]	Length [mm]	Spacing [mm]	Indicative quantities
Adjustable steel bracket for C profile	50 (60)	-	800 * ¹	2.10 pcs/m ² C profiles every 600 mm
				2.50 pcs/m ² C profiles every 500 mm
				3.10 pcs/m ² C profiles every 400 mm
C profile	27x50x27 (27x60x27)	3000/4000	600	1.70 m/m ²
			500	2.00 m/m ²
			400	2.30 m/m ²
U-shaped perimeter guide	28x30x28	3000/4000	-	Perimeter * ²

Application with clip steel profiles and C profiles

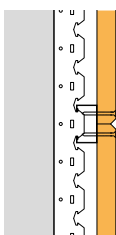

Type	Section [mm]	Length [mm]	Spacing [mm]	Indicative quantities
Primary galvanized steel clip profile for C profile	40x28	4000	800	1.15 m/m ²
			600	1.70 m/m ²
			600	1.70 m/m ²
C profile	27x50x27 (27x60x27)	3000/4000	500	2.00 m/m ²
			400	2.30 m/m ²
			U-shaped perimeter guide	28x30x28

Application with double C profiles

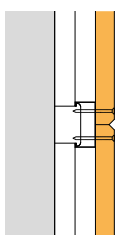

Type	Section [mm]	Length [mm]	Spacing [mm]	Indicative quantities
Primary C profile	27x50x27 (27x60x27)	3000/4000	900	1.11 m/m ²
			800	1.15 m/m ²
			600	1.70 m/m ²
Galvanized steel fixed spacer for C profile	50x30 (30x60)	-	-	- * ³
Secondary C profile	27x50x27 (27x60x27)	3000/4000	600	1.70 m/m ²
			500	2.00 m/m ²
			400	2.30 m/m ²
U-shaped perimeter guide	28x30x28	3000/4000	-	Perimeter * ²

*¹ The spacing between the hangers (spacers/ brackets) is the distance between them along the bearing profile

*² The quantities of the U-shaped guide is equal to the perimeter of the false ceiling

*³ The quantities of fixed spacer to use is equal to the number of crosses between primary structure and secondary structure

False wall with CELENIT AB 25 mm thick, ball impact resistant according to DIN 18032/Part 3 standards

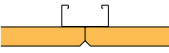
	Type of board	Structure	Certificate * No. / Date	Standard	Results
	CELENIT AB Thickness: 25 mm Dimensions: 1200x600 mm Edges: Chamfered - S4	C metal section 27x60x27 mm Distance between centers of cross joists: 300 mm Distance between centers of main joists: 600 mm Number of screws per board: 9	324044 27.04.2015	DIN 18032-3	Visual examination Pass

* The certificate is based on tests carried out at the Giordano Institute (Bellaria - RN - Italy)

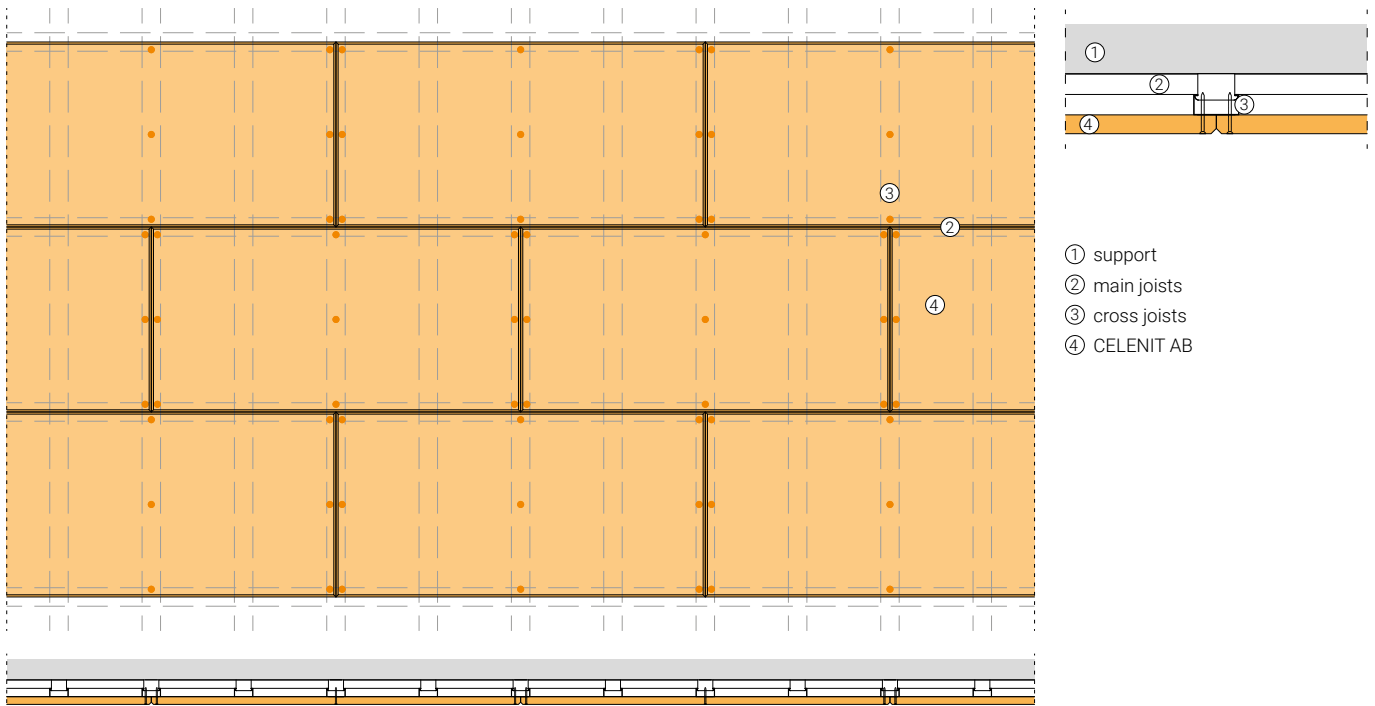

Description

CELENIT AB boards dimensions 1200x600 mm, 25 mm thick, with chamfered edges on 4 sides (code S4) with staggered laying on the short side. Boards are optionally painted and directly fixed to the cross joists made of C-shaped steel profile, section 60x27 mm and thickness 0.6 mm, placed orthogonally with a distance between centers of 300 mm. Cross joists

are supported by main joists made of C-shaped steel profile, section 60x27 mm and thickness 0.6 mm, placed orthogonally with a distance between centers of 600 mm. The boards are fixed on the underside to the cross joists using self-tapping screws, diameter 3.5 mm and spacing 300x600 mm (9 screws per board).

Test results

Impacts	Impact angle	Nominal velocity [m/s]	Visual examination *
30	90°	23.5 ± 1.2	Pass
12	45°		Pass
12	45° (opposite direction)		Pass

* After firing the shots in accordance with clause 7 "Auswertung" of standard DIN 18032-3:1997, the strength, function and safety of the wall elements are not adversely affected and their appearance has not changed.

False wall with CELENIT AB 35 mm thick, ball impact resistant according to DIN 18032/Part 3 standards

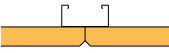
	Type of board	Structure	Certificate * No. / Date	Standard	Results
	CELENIT AB Thickness: 35 mm Dimensions: 1200x600 mm Edges: Chamfered - S4	C metal section 27x60x27 mm Distance between centers of cross joists: 600 mm Distance between centers of main joists: 600 mm Number of screws per board: 9	324043 27.04.2015	DIN 18032-3	Visual examination Pass

* The certificate is based on tests carried out at the Giordano Institute (Bellaria - RN - Italy)

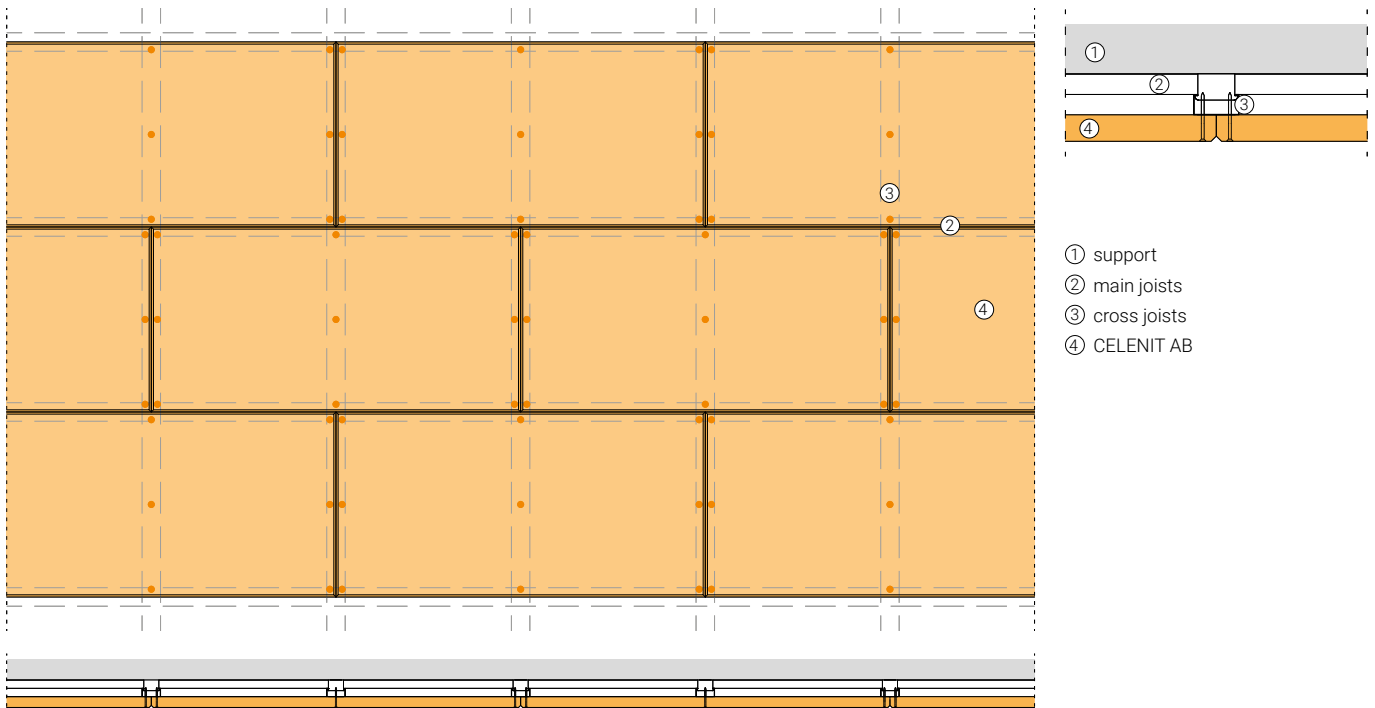

Description

CELENIT AB boards dimensions 1200x600 mm, 35 mm thick, with chamfered edges on 4 sides (code S4) with staggered laying on the short side. Boards are optionally painted and directly fixed to the cross joists made of C-shaped steel profile, section 60x27 mm and thickness 0.6 mm, placed orthogonally with a distance between centers of 600 mm. Cross joists

are supported by main joists made of C-shaped steel profile, section 60x27 mm and thickness 0.6 mm, placed orthogonally with a distance between centers of 600 mm. The boards are fixed on the underside to the cross joists using self-tapping screws, diameter 3.5 mm and spacing 300x600 mm (9 screws per board).

Test results

Impacts	Impact angle	Nominal velocity [m/s]	Visual examination *
30	90°	23.5 ± 1.2	Pass
12	45°		Pass
12	45° (opposite direction)		Pass

* After firing the shots in accordance with clause 7 "Auswertung" of standard DIN 18032-3:1997, the strength, function and safety of the wall elements are not adversely affected and their appearance has not changed.

Storage, use and maintenance

The boards must be stored on a pallet placed on a flat surface, protected from rain and direct sunlight. Pallets must be handled with care on site. Bumping the corners of the pallets can cause damage to the boards. For more information see the "Storage, use and maintenance" information (page 108) available in the download area of the website www.celenit.com.



CELENIT boards are dimensionally stable (EN 13168), however, they must be installed after acclimating to the same room they are going to be installed in, as well as after all concrete works are finished and the doors, windows, heating and ventilation systems have been installed.

Room temperature must be kept constant before and after installation. Do not suddenly change the temperature of the room after installation.

General installation instructions

- The boards have one side that should be visible (front of the board) and another side that should be placed against the structure (back of the board). The back of the board usually has the CELENIT logo or shows calibration marks. The front may be painted and/or has worked edges. In the absence of paint or edges, the front can be identified according to the pallet layout: the front of the boards faces the top and the back faces the pallet.
- With the aid of a laser level mark the positions for the fixings of the fixed elements (fixed spacer, brackets, clip steel profile) and fix them.
- Design the secondary profiles position starting from the center of the ceiling to have a symmetric layout. The structure will be connected to the spacer elements or clip profiles by aligning them with a laser leveler.
- If a vapour barrier is necessary, it'll install on the secondary profile with butyl double-sided adhesive tape. The tape also acts as a seal for the fixings of CELENIT boards.
- Fix the boards to the structure according to fixing schemes at page 59. Take maximum care while handling the panels. Corners and paint are easy to damage. Use clean gloves when installing the panels. Please find more information on stocking, use and maintenance (page 108) at www.celenit.com.
- We recommend boards with chamfered edges and staggered laying on the short side to ensure a nicer visual effect. The installation of boards with straight edge may be possible anyway.
- It is possible to insert mineral wool panels or wood fiber panels in the background of CELENIT panels to improve acoustic and thermal performances while laying CELENIT boards.
- After the installation please follow the recommendations in the section "Storage, use and maintenance" (page 108) at www.celenit.com.

Important remarks

15 mm panels are not recommended for outdoor applications (with a roof protection) or in presence of high humidity.

CELENIT boards with DT edges code are not available because dimensions are not suitable for this system.



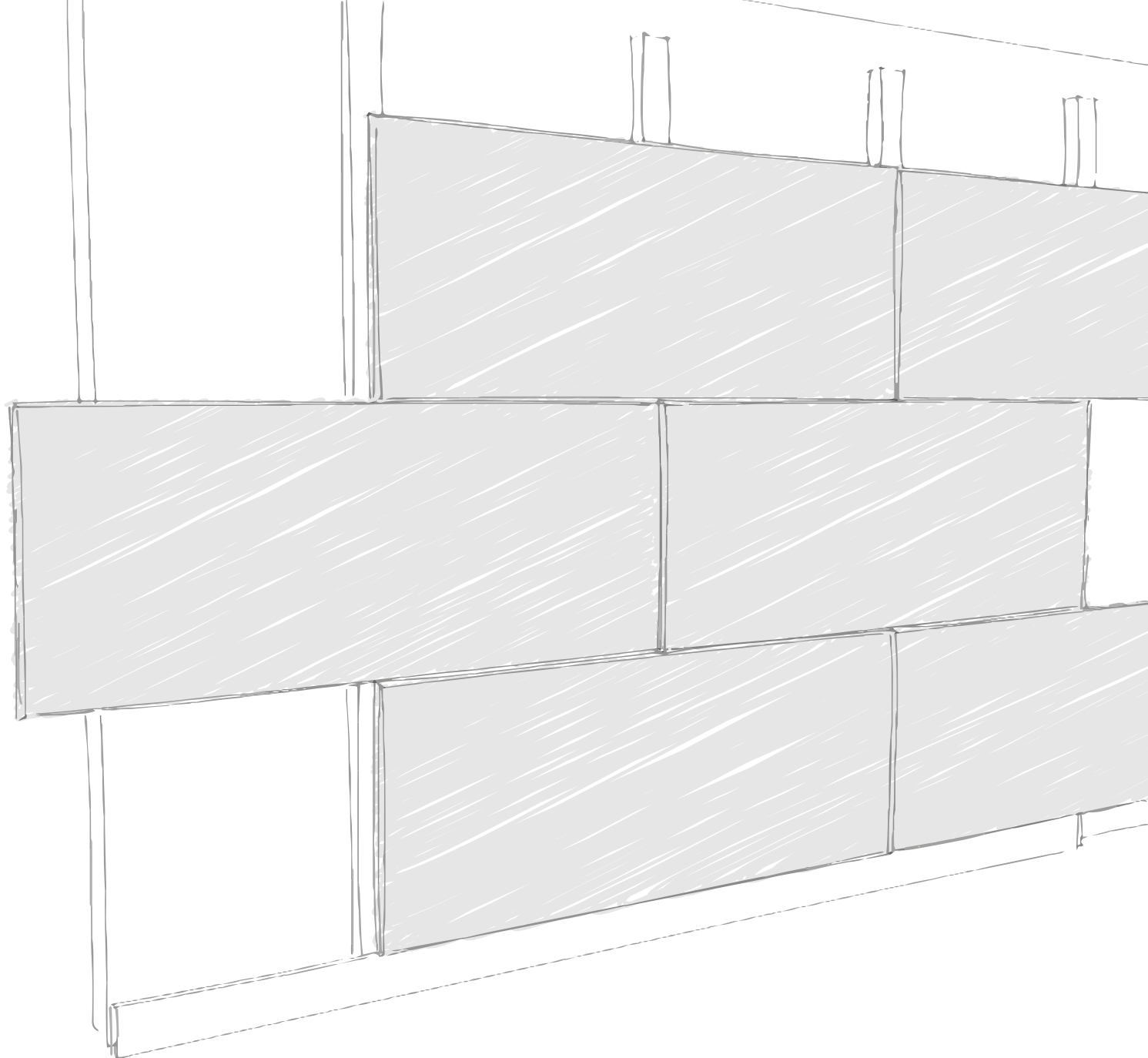

WALL COVERINGS
**HIDDEN WOODEN
STRUCTURE**

Item specifications

CELENIT sound absorbing wall coverings with hidden wooden structure, model ACOUSTIC ..., with thermal and acoustic insulation, eco-friendly and sound absorbing boards - CELENIT ... product range, CELENIT ... item No. ... - made of mineralized ... fir wood wool bound with white Portland cement, it complies with EN 13168 and EN 13964 standards, it can be coupled with rock wool (ACOUSTIC MINERAL product range); dim.: ... x ... mm; th.: ... mm; texture: ...; straight edges (code: D) or chamfered edges (code: S4); weight: ... kg/m²; λ_D : ... W/mK; R_D : ... m²K/W; compressive stress σ_{10} : \geq ... kPa; water vapour transmission μ : 5; reaction to fire: Euroclass B-s1, d0 or A2-s1, d0 (EN 13501-1 standard); sound absorption: α_w ... / NRC ...; durability: class C; light reflection: 50.7 o 74.0% (painted white 05/15); release of formaldehyde: class E1; it does not contain asbestos.

Wood wool boards must be certified by ANAB-ICEA and natureplus for eco-compatibility of materials and manufacturing process, PEFC™ or FSC® for the sustainability of wood raw material, ICEA for the content of recycled material and for the attestation of LEED credits, EPD for the environmental statement.

Wood laths dimensions ... x ... mm; spacing between primary laths: ... mm; spacing between secondary laths: ... mm; fixings per boards: ...; screws diameter: 3.5 mm; screws spacing: ... x ... mm.

Products



CELENIT ACOUSTIC range
ABE - AB

CELENIT ACOUSTIC A2 range
ABE/A2 - AB/A2

Boards made of mineralized wood wool bound with white Portland cement



Straight edges
D for all thicknesses



Chamfered edges
S4 for all thicknesses



Shiplap edges
RD10 for thicknesses 25 - 35 mm
RD20 for thicknesses 25 - 35 mm



CELENIT ACOUSTIC MINERAL range
L2ABE25 - L2AB25 - L2ABE25C

CELENIT ACOUSTIC MINERAL A2 range
L2ABE25/A2 - L2AB25/A2 - L2ABE25C/A2

Boards made of mineralized wood wool bound with white Portland cement coupled to a layer of rock wool



Straight edges
D for all thicknesses



Chamfered edges
S4 for all thicknesses

The boards are supplied with dimensions 1200x600 mm with rock wool 1200x500 mm, for direct application to the structure.

Except for **L2ABE25C** and **L2ABE25C/A2** which are supplied with rock wool 1200x600 mm and sufficient compression strength to avoid crushing during the laying. They can be screwed directly to the structure, either with orthogonal or parallel installation.

Single structure

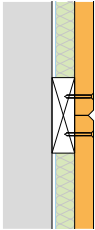

- System used to minimize the total thickness.
- Wood laths anchored to the wall with suitable fixings depending on the type of the support, or with adjustable brackets.
- Wood laths dimensions:
 - for CELENIT ACOUSTIC panels, recommended section (BxH) 60x40 mm or 80x40 mm
 - for CELENIT ACOUSTIC MINERAL panels, max. width 95 mm, min. height 30 mm
- Boards fixed directly to the wood laths according to the fixing schemes (page 70).

Double structure

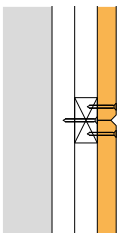

- The system is compatible to wall coverings with ball-impact resistant certification with CELENIT ABE boards (page 71).
- Primary structure anchored to the wall with suitable fixings depending on the type of the support, or with lowering elements.
- Wood laths dimensions:
 - for CELENIT ACOUSTIC panels, recommended section (BxH) 60x40 mm or 80x40 mm
 - for CELENIT ACOUSTIC MINERAL panels, max. width 95 mm, min. height 30 mm
- Boards fixed directly to the wood laths according to the fixing schemes (page 70).

Orthogonal installation to the structure

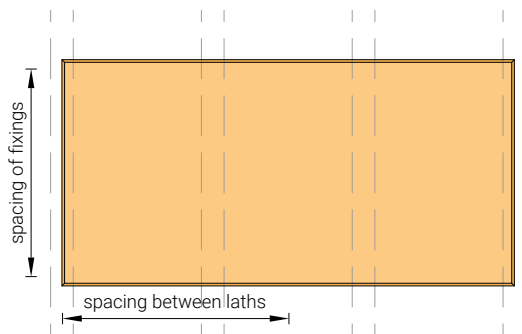

Only for CELENIT ACOUSTIC panels.

Board thickness [mm]	Dimensions [mm]	Spacing between laths [mm]
15	600x600	300
	1200x600	400
25 / 35	600x600	600
	1200x600	600
	2000x600	500
	2400x600	600

Parallel installation to the structure

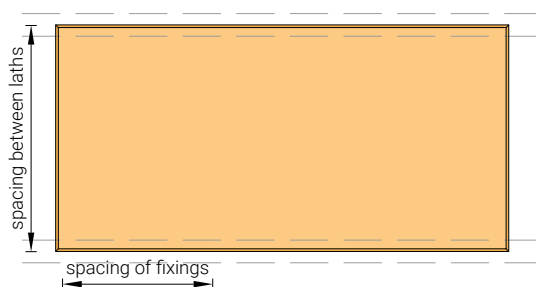

Available for CELENIT ACOUSTIC MINERAL boards or CELENIT ACOUSTIC boards.

Wood laths fixed every 600 mm (boards width).

Orthogonal installation to the structure

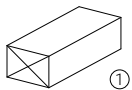
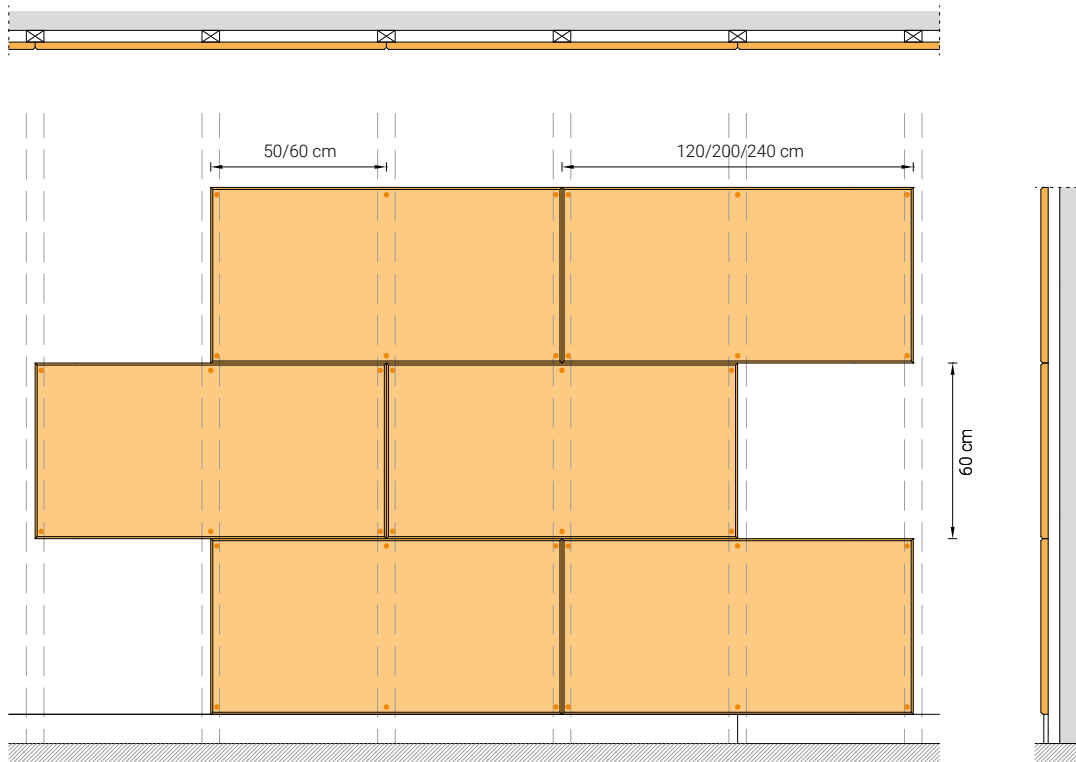

Wood laths
Recommended sections (BxH): 60x40 mm or 80x40 mm



Self-tapping screw for wood
White zinc-plated
Countersunk head with cross, fully threaded,
professional lubricant covering
Dimensions 4.5x35 - 4.5x45 - 4.5x60

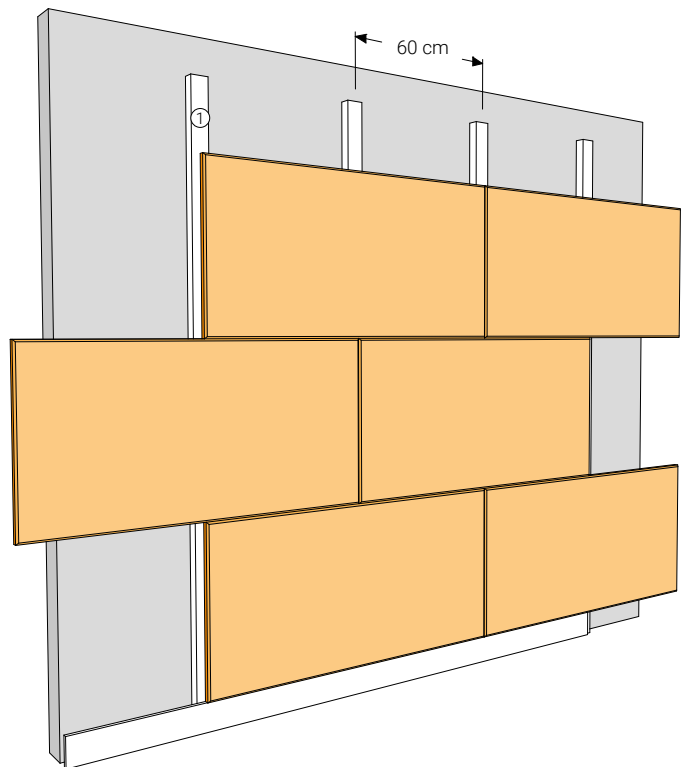

Parallel installation to the structure

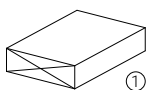
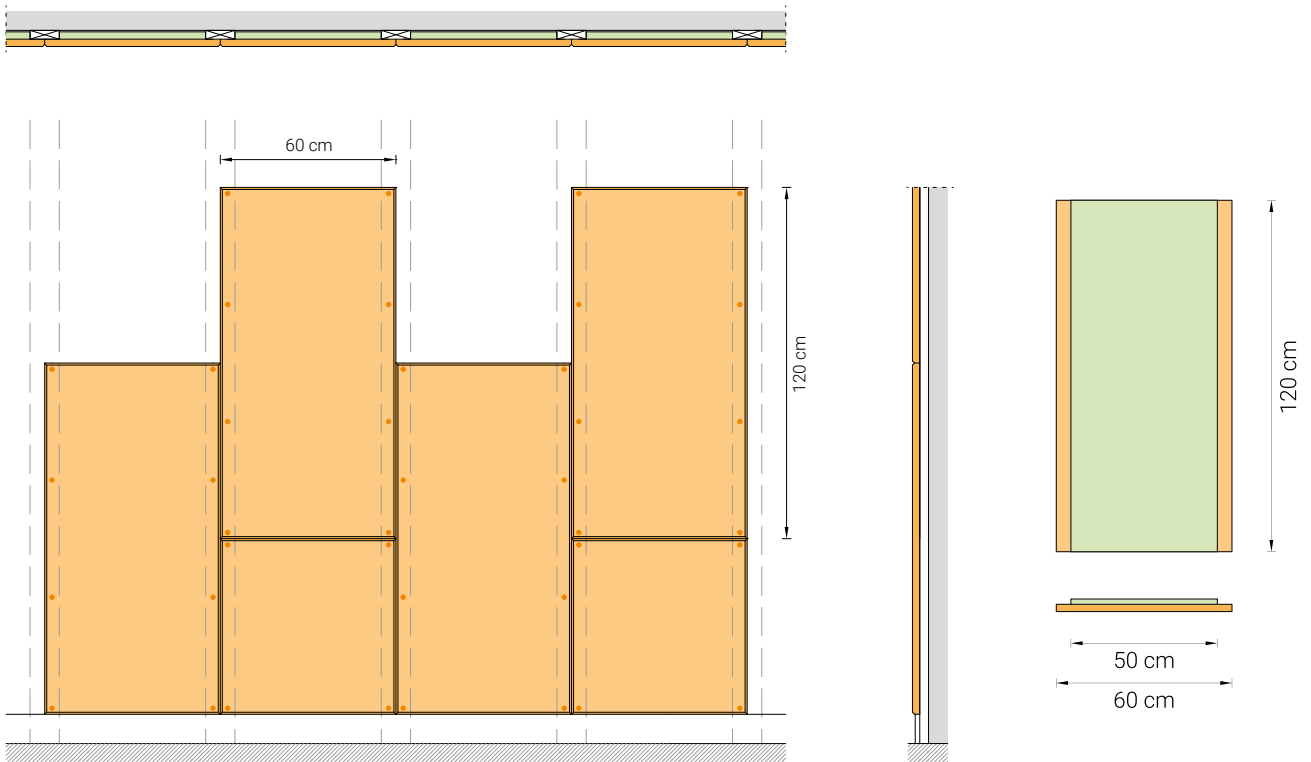

Wood laths
 Wood laths dimensions:
 • with CELENIT ACOUSTIC panels the recommended sections (BxH) are 60x40 mm or 80x40 mm
 • with CELENIT ACOUSTIC MINERAL panels, width max. 95 mm, height min. 30 mm



Self-tapping screw for wood
 White zinc-plated
 Countersunk head with cross, fully threaded, professional lubricant covering
 Dimensions 4.5x35 - 4.5x45 - 4.5x60

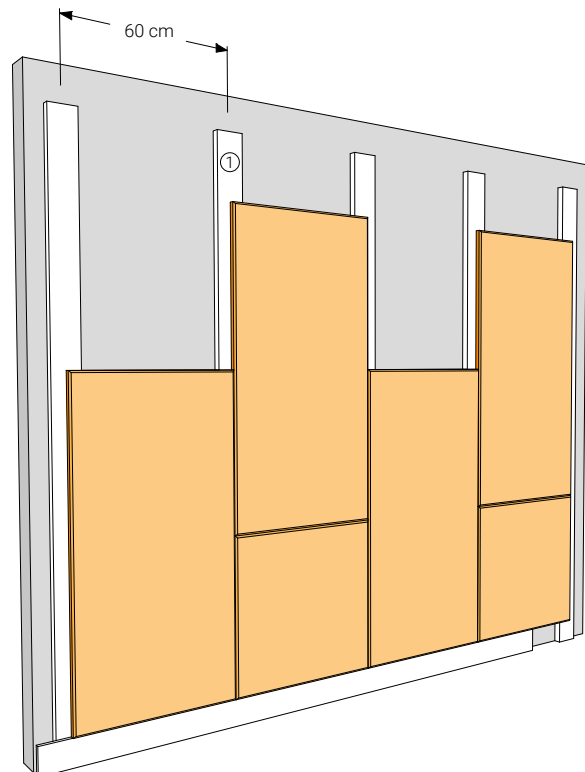

Fixings schemes

CELENIT ACOUSTIC range

• thickness 15 mm

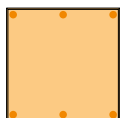

600x600 mm - 6 screws
Orthogonal installation:
 Spacing of fixings 600 mm
 Wood laths fixed every 300 mm

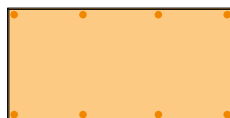

1200x600 mm - 8 screws
Orthogonal installation:
 Spacing of fixings 600 mm
 Wood laths fixed every 400 mm

• thicknesses 25/35 mm

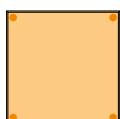

600x600 mm - 4 screws
Orthogonal/parallel installation:
 Spacing of fixings 600 mm
 Wood laths fixed every 600 mm



2000x600 mm - 10 screws
Parallel installation:
 Spacing of fixings 500 mm
 Wood laths fixed every 600 mm
Orthogonal installation:
 Spacing of fixings 600 mm
 Wood laths fixed every 500 mm



1200x600 mm - 6 screws
Parallel installation:
 Spacing of fixings 600 mm
 Wood laths fixed every 600 mm
Orthogonal installation:
 Spacing of fixings 600 mm
 Wood laths fixed every 600 mm



2400x600 mm - 10 screws
Orthogonal/parallel installation:
 Spacing of fixings 600 mm
 Wood laths fixed every 600 mm

Board thickness [mm]	Dimensions [mm]	Screws per board [No.]	Screws per m ² [No./m ²]	Screw dimensions [mm]
15	600x600	6	16.7	4.5x35
	1200x600	8	11.2	
25	600x600	4	11.2	4.5x45
	1200x600	6	8.4	
	2000x600	10	8.4	
35	2400x600	10	7.0	4.5x60
	600x600	4	11.2	
	1200x600	6	8.4	
	2000x600	10	8.4	
	2400x600	10	7.0	

CELENIT ACOUSTIC MINERAL range

• wood wool thickness 25 mm



1200x600 mm - 8 screws
Parallel installation:
 Spacing of fixings 400 mm
 Wood laths fixed every 600 mm

Wood wool board thickness [mm]	Dimensions [mm]	Screws per board [No.]	Screws per m ² [No./m ²]	Screw dimensions [mm]
25	1200x600	8	11.2	4.5x45

False wall with CELENIT ABE 35 mm thick, ball impact resistant according to DIN 18032/Part 3 standards

	Type of board	Structure	Certificate * No. / Date	Standard	Results
	CELENIT ABE Thickness: 35 mm Dimensions: 1200x600 mm Edges: Chamfered - S4	Wooden battens size 60x30 mm Distance between centers of cross laths: 600 mm Distance between centers of main laths: 600 mm Number of screws per board: 9	324042 27.04.2015	DIN 18032-3	Visual examination Pass

* The certificate is based on tests carried out at the Giordano Institute (Bellaria - RN - Italy)

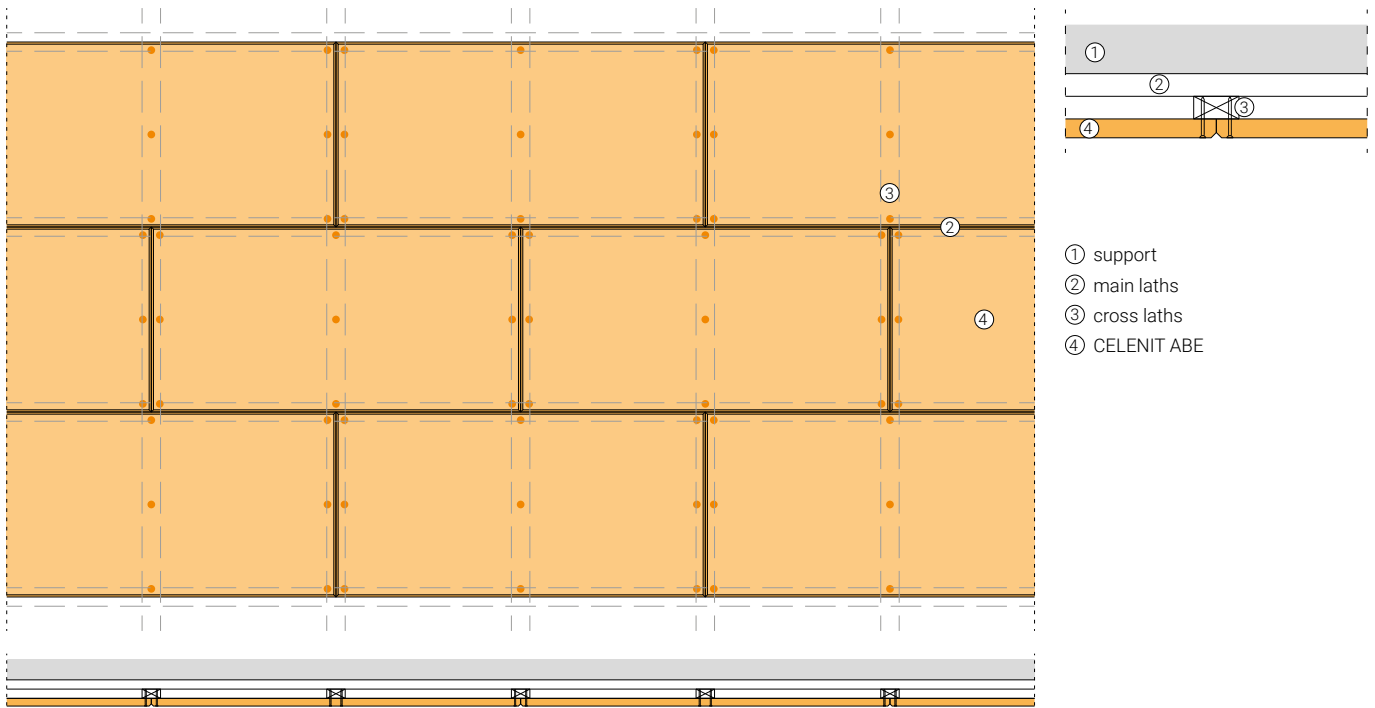

Description

CELENIT ABE boards dimensions 1200x600 mm, 25 mm thick, with chamfered edges on 4 sides (code S4) with staggered laying on the short side. Boards are optionally painted and directly fixed to the cross wood laths, section 60x30 mm, placed orthogonally with a distance between centers of 600 mm. Cross wood laths are supported by main wood laths,

section 60x30 mm, placed orthogonally with a distance between centers of 600 mm. The boards are fixed on the underside to the cross wood laths using self-tapping screws, diameter 3.5 mm and spacing 300x600 mm (9 screws per board).

Test results

Impacts	Impact angle	Nominal velocity [m/s]	Visual examination ¹
30	90°	23.5 ± 1.2	Pass
12	45°		Pass
12	45° (opposite direction)		Pass

¹ After firing the shots in accordance with clause 7 "Auswertung" of standard DIN 18032-3:1997, the strength, function and safety of the wall elements are not adversely affected and their appearance has not changed.

Storage, use and maintenance

The boards must be stored on a pallet placed on a flat surface, protected from rain and direct sunlight. Pallets must be handled with care on site. Bumping the corners of the pallets can cause damage to the boards. For more information see the "Storage, use and maintenance" information (page 108) available in the download area of the website www.celenit.com.



CELENIT boards are dimensionally stable (EN 13168), however, they must be installed after acclimating to the same room they are going to be installed in, as well as after all concrete works are finished and the doors, windows, heating and ventilation systems have been installed.

Room temperature must be kept constant before and after installation. Do not suddenly change the temperature of the room after installation.

General installation instructions

- The boards have one side that should be visible (front of the board) and another side that should be placed against the structure (back of the board). The back of the board usually has the CELENIT logo or shows calibration marks. The front may be painted and/or has worked edges. In the absence of paint or edges, the front can be identified according to the pallet layout: the front of the boards faces the top and the back faces the pallet.
- Fix the bearing laths starting from the center of the wall to have a symmetric layout. Wood laths will be fixed directly to the wall with suitable screw or with adjustable brackets. With the aid of a laser level fix the wood laths to the brackets with no. 2 screws per side.
- Fix the secondary structure to the primary with no. 2 screws per intersection.
- If a vapour barrier is necessary, it'll install on the last laths with butyl double-sided adhesive tape. The tape also acts as a seal for the fixings of CELENIT boards.
- Fix the boards to the structure according to fixing schemes at page 70. Take maximum care while handling the panels. Corners and paint are easy to damage. Use clean gloves when installing the panels. Please find more information on stocking, use and maintenance (page 108) at www.celenit.com.
- We recommend to fix the screws the screws to the wood laths with an inclination of about 5°-6° to give more tightness to the screws on the support.
- We recommend boards with chamfered edges and staggered laying on the short side to ensure a nicer visual effect. The installation of boards with straight edge may be possible anyway.
- It is possible to insert mineral wool panels or wood fiber panels on top of CELENIT panels to improve acoustic and thermal performances while laying CELENIT boards.
- After the installation please follow the recommendations in the section "Storage, use and maintenance" (page 108) at www.celenit.com.

Important remarks

15 mm panels are not recommended for outdoor applications (with a roof protection) or in presence of high humidity.

CELENIT boards with DT edges code are not available because dimensions are not suitable for this system.



STREET - FOOD & BEERS EXPERIENCE Milano, IT
design: Roberto Cornacchio | photo: Alessia Mora

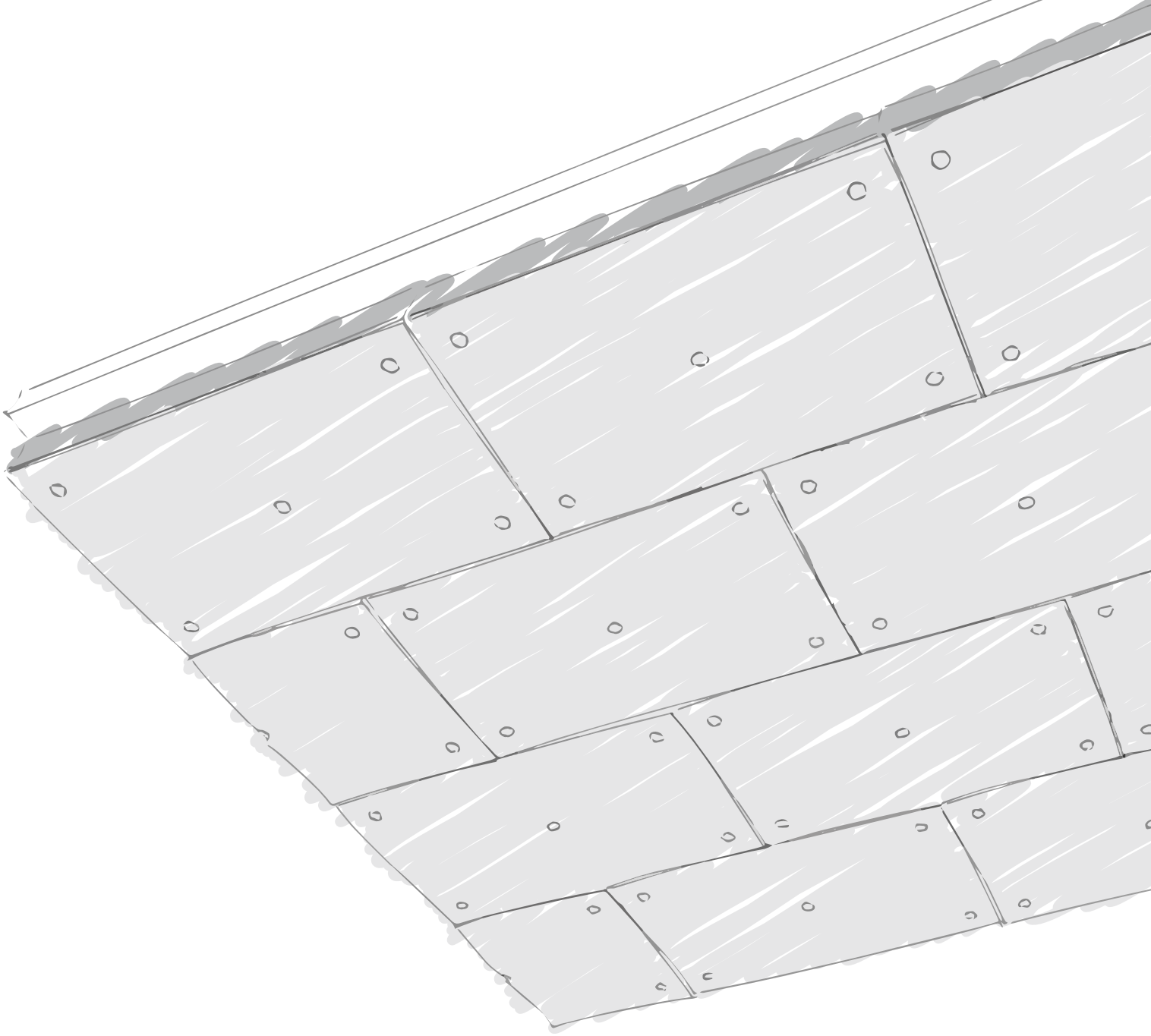

COVERINGS WITH MECHANICAL FIXINGS

Item specifications

CELENIT thermal insulation and sound absorbing coverings, for ceilings and walls with mechanical fixings, model ACOUSTIC ..., with thermal and acoustic insulation, eco-friendly and sound absorbing boards - CELENIT ... product range, CELENIT ... item No. ... - made of mineralized ... fir wood wool bound with white Portland cement, it complies with EN 13168 and EN 13964 standards, it can be coupled with rock wool or polystyrene (ACOUSTIC MINERAL/STYR product range); dim.: ... x ... mm; th.: ... mm; texture: ...; straight edges (code: D) or chamfered edges (code: S4); weight: ... kg/m²; λ_D : ... W/mK; R_D : ... m²K/W; compressive stress σ_{10} : \geq ... kPa; water vapour transmission μ : 5; reaction to fire: Euroclass B-s1, d0 or A2-s1, d0 (EN 13501-1 standard); sound absorption: α_w ... /

NRC ...; durability: class C; light reflection: 50.7 o 74.0% (painted white 05/15); release of formaldehyde: class E1; it does not contain asbestos.

Wood wool boards must be certified by ANAB-ICEA and natureplus for eco-compatibility of materials and manufacturing process, PEFC™ or FSC® for the sustainability of wood raw material, ICEA for the content of recycled material and for the attestation of LEED credits, EPD for the environmental statement.

Mechanical fixing with self-tapping DDS or DDS-Z screws for reinforced concrete support; self-tapping screws with countersunk head for wooden support.

Products



CELENIT ACOUSTIC range
ABE - AB

CELENIT ACOUSTIC A2 range
ABE/A2 - AB/A2

Boards made of mineralized wood wool bound with white Portland cement



Straight edges
D for all thicknesses



Chamfered edges
S4 for all thicknesses



CELENIT ACOUSTIC MINERAL range
L2ABE25C

CELENIT ACOUSTIC MINERAL A2 range
L2ABE25C/A2

CELENIT MINERAL range
L2AB

CELENIT MINERAL A2 range
L2ABE/A2 - L2AB/A2

Boards made of mineralized wood wool bound with white Portland cement coupled to a layer of rock wool



Straight edges
D for all thicknesses



Chamfered edges
S4 for CELENIT L2ABE25C and
CELENIT L2ABE25C/A2 boards

S47 for CELENIT L2AB - CELENIT L2ABE/A2 -
CELENIT L2AB/A2 boards

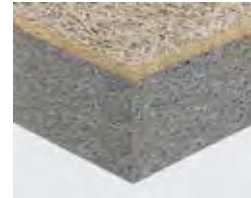

CELENIT STYR range
G2AB

Boards made of mineralized wood wool bound with white Portland cement coupled to a layer of polystyrene



Straight edges
D for all thicknesses



Chamfered edges
S47 for all thicknesses

Technical notes

- The boards used for direct application to the ceiling/wall with mechanical fixings combine sound absorption and fire protection performance with thermal insulation properties
- The aesthetic finish of the wood wool allows to avoid the application of plaster or plasterboards
- The compressive strength of wood wool and the compressive strength of the inner layer (rock wool or polystyrene) of coupled boards allow the direct applications to the ceiling/wall without crushing the panels
- The fixing system is aesthetically non-invasive

Applications

- Thermal insulation, sound absorption and fire protection of ceilings with direct application using mechanical fixings
- Thermal insulation, sound absorption and fire protection of walls with direct application using mechanical fixings

System

The type of screws and the fixings scheme change depending on the type of ceiling/wall. Generally this application system is used where the support is continuous over the entire surface (reinforced concrete or wooden ceiling/wall). If the support is

discontinuous (reinforced concrete slab with lightning element or timber framed structures) the distance between the load bearing elements should be carefully evaluated.

Fixing with mechanical fixings on reinforced concrete support

- Boards are directly fixed to the support with self-tapping mechanical fixings, DDS or DDS-Z
- The head diameter and wood wool structure simulation allow the camouflage of fixing in the texture of wood wool board
- Also suitable for application on discontinuous horizontal partitions, such as reinforced concrete slab with lightning element, after the verification of the distance between the load bearing elements (fixings must be positioned in correspondence of load-bearing elements not on the lightning elements)

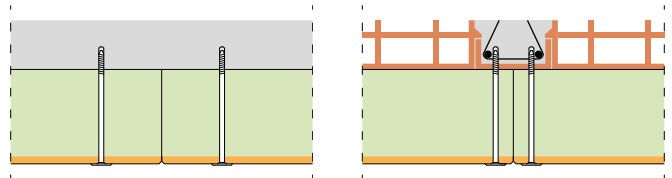

Fixing with screws on wooden support

- Boards are directly fixed to the support with self-tapping screws with countersunk head
- The countersunk head allows to enter inside the thickness of the wood wool board, while the porosity of the panel allows the camouflage of fixings
- Also suitable for application on discontinuous horizontal partitions such as timber framed structures, after the verification of the distance between the load bearing elements where fixings must be positioned

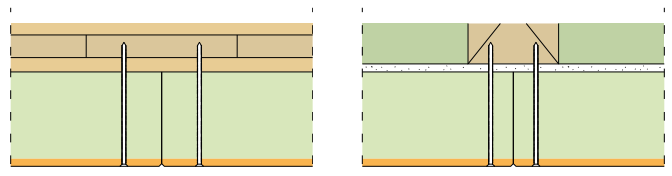

Fixing with self-tapping mechanical fixings

on reinforced concrete

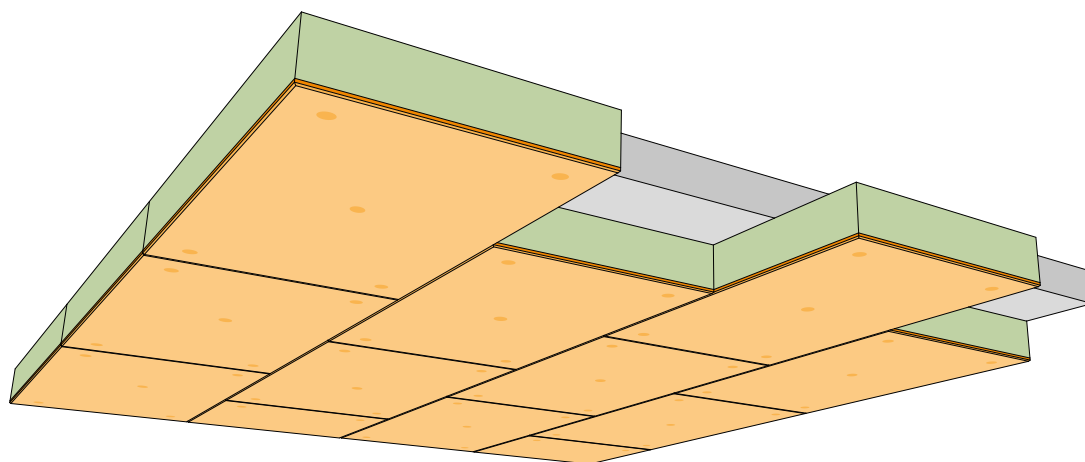
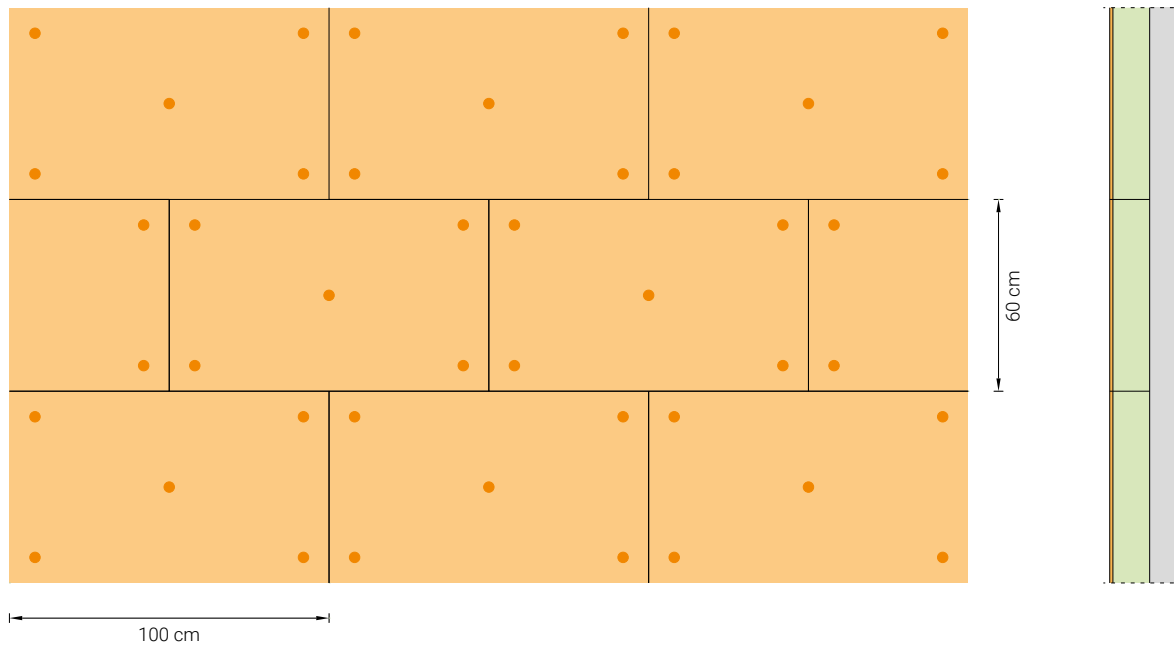

Accessories



DDS mechanical fixings



DDS-Z mechanical fixings

Fixing specifications

Boards are directly fixed to the support with self-tapping mechanical fixings, DDS or DDS-Z.

The hole has to be 30 mm depth and with a diameter of 6 mm; the depth penetration of the fixing has to be of 25 mm, therefore the DDS anchorage length will be determined by the thickness of the boards chosen.

The panels will be supplied with straight, shiplap or chamfered edges according to the aesthetic needs. They can be painted after their installation.

! In reinforced concrete slab with lightning element boards must be fixed on the beams and not on the lightning element.

Panel thickness [mm]	Fixings height [mm]
≤ 50	75
> 50 ≤ 75	100
> 75 ≤ 100	125
> 100 ≤ 125	150
> 125 ≤ 150	175
> 150 ≤ 175	200

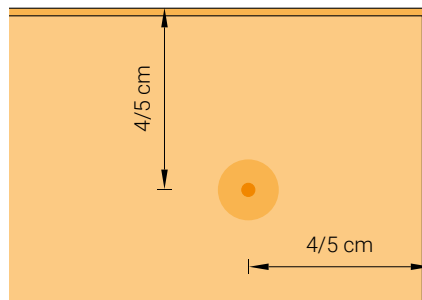

DDS

- Direct self-tapping screw for fixing on concrete
- Plastic injection moulded head with wood wool structure simulation
- Colors of screw head: white, beige (other RAL on request)
- Installation: drilling and screwing
- Head diameter: 25 mm
- Metal insert for fixing the screw: TORX T30



DDS-Z

- Direct self-tapping screw with corrosion resistance, for fixing on concrete
- Galvanized steel flat-head
- Colors of screw head: white RAL 9002 powder coated (other RAL on request)
- Installation: drilling and screwing
- Head diameter: 24 mm
- Corrosion resistance certification: C1-C3
- Metal insert for fixing the screw: TORX T30



Fixing with self-tapping screws

on wooden support

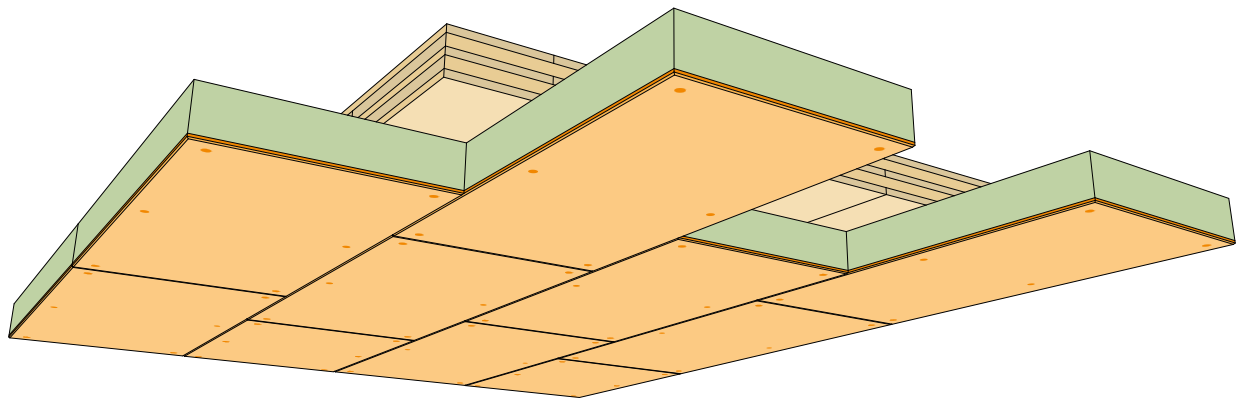
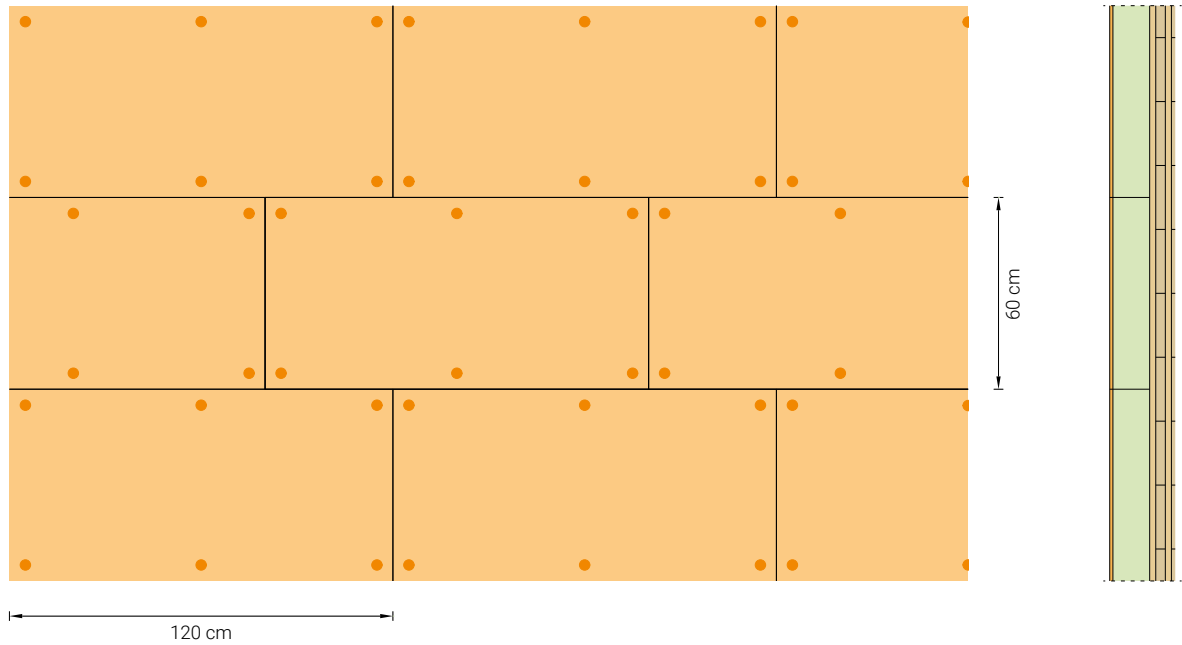

Accessori



Self-tapping screw for wood
Countersunk head

Fixing specifications

Boards are directly fixed to the support with self-tapping screws for wood with countersunk head; the depth penetration of the fixing has to be of 40 mm. Screw length will be determined by the thickness of the boards chosen.

The panels will be supplied with straight, shiplap or chamfered edges according to the aesthetic needs. They can be painted after their installation.

! We recommend to fix the screws with a slight inclination to give more tightness to the screws on the support.

Panel thickness [mm]	Fixings height [mm]
50	90
75	115
80	120
85	125
100	140
105	145
125	165
145	185
150	190
160	200
175	215

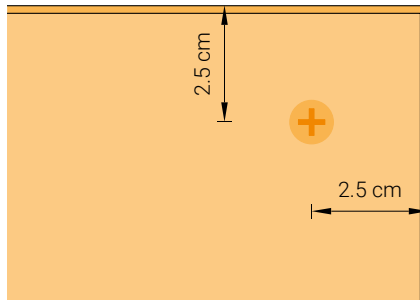

Self-tapping screw

- Self-tapping screw for wood
- Countersunk head
- Material: stainless steel
- Installation: direct screwdriving without pre-drilling
- Depending on the thickness and weight of the panel consider the use of a washer to give more tightness



Fixings schemes

Fixing on continuous reinforced concrete support

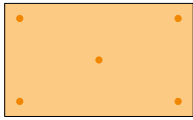

1000x600 mm - 5 fixings
Fixings scheme:
600x1000 mm + central fixing

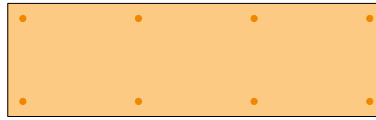

2000x600 mm - 8 fixings
Fixings scheme: 600x667 mm

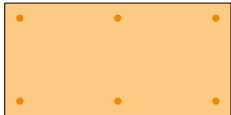

1200x600 mm - 6 fixings
Fixings scheme: 600x600 mm



2400x600 mm - 10 fixings
Fixings scheme: 600x600 mm

Dimensions [mm]	Fixings per board [No.]	Fixings per m ² [No./m ²]	Fixings scheme [mm]	Fixing type	Fixings height ¹ [mm]
CELENIT ACOUSTIC range					
1200x600	6	8.3	600x600	Self-tapping mechanical fixings for reinforced concrete (see page 5)	≤ 75
2000x600	8	6.7	600x667		
2400x600	10	6.9	600x600		
CELENIT MINERAL / CELENIT STYR ranges					
1000x600	5	8.3	600x1000 + central fixing	Self-tapping mechanical fixings for reinforced concrete (see page 5)	≤ 200
1200x600	6	8.3	600x600		
2000x600	8	6.7	600x667		

Fixing on continuous wooden support



1000x600 mm - 6 fixings
Fixings scheme: 600x500 mm



2000x600 mm - 10 fixings
Fixings scheme: 600x500 mm



1200x600 mm - 6 fixings
Fixings scheme: 600x400 mm

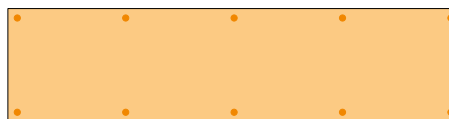

2400x600 mm - 10 fixings
Fixings scheme: 600x600 mm

Dimensions [mm]	Fixings per board [No.]	Fixings per m ² [No./m ²]	Fixings scheme [mm]	Fixing type	Fixings height ¹ [mm]
CELENIT ACOUSTIC range ²					
1200x600	6	8.4	600x400	Self-tapping screw for wood with countersunk head (see page 7)	≤ 90
2000x600	10	8.4	600x500		
2400x600	10	7.0	600x600		
CELENIT MINERAL / CELENIT STYR ranges					
1000x600	6	10.0	600x400	Self-tapping screw for wood with countersunk head (see page 7)	≤ 210
1200x600	6	8.4	600x500		
2000x600	10	7.0	300x667		

¹ Fixings length will be determined by the thickness of the boards chosen. See "Fixing specifications" at page 5 (reinforced concrete support) or page 7 (wooden support)

² Only for 25/35 mm board thicknesses. Evaluate the appropriate fixing scheme for board 50 mm thick

Storage, use and maintenance

The boards must be stored on a pallet placed on a flat surface, protected from rain and direct sunlight. Pallets must be handled with care on site. Bumping the corners of the pallets can cause damage to the boards. For more information see the "Storage, use and maintenance" information (page 108) available in the download area of the website www.celenit.com.



CELENIT boards are dimensionally stable (EN 13168), however, they must be installed after acclimating to the same room they are going to be installed in, as well as after all concrete works are finished and the doors, windows, heating and ventilation systems have been installed.

Room temperature must be kept constant before and after installation. Do not suddenly change the temperature of the room after installation.

General installation instructions

- The boards have one side that should be visible (front of the board) and another side that should be placed against the structure (back of the board). The back of the board usually has the CELENIT logo or shows calibration marks. The front may be painted and/or has worked edges. In the absence of paint or edges, the front can be identified according to the pallet layout: the front of the boards faces the top and the back faces the pallet.
- After the installation please follow the recommendations in the section "Storage, use and maintenance" (page 108) at www.celenit.com.



COPERNICO TORTONA Milano, IT
design: Bunker arc, Torricelli Associati, Weltgebras | photo: Alessia Mora

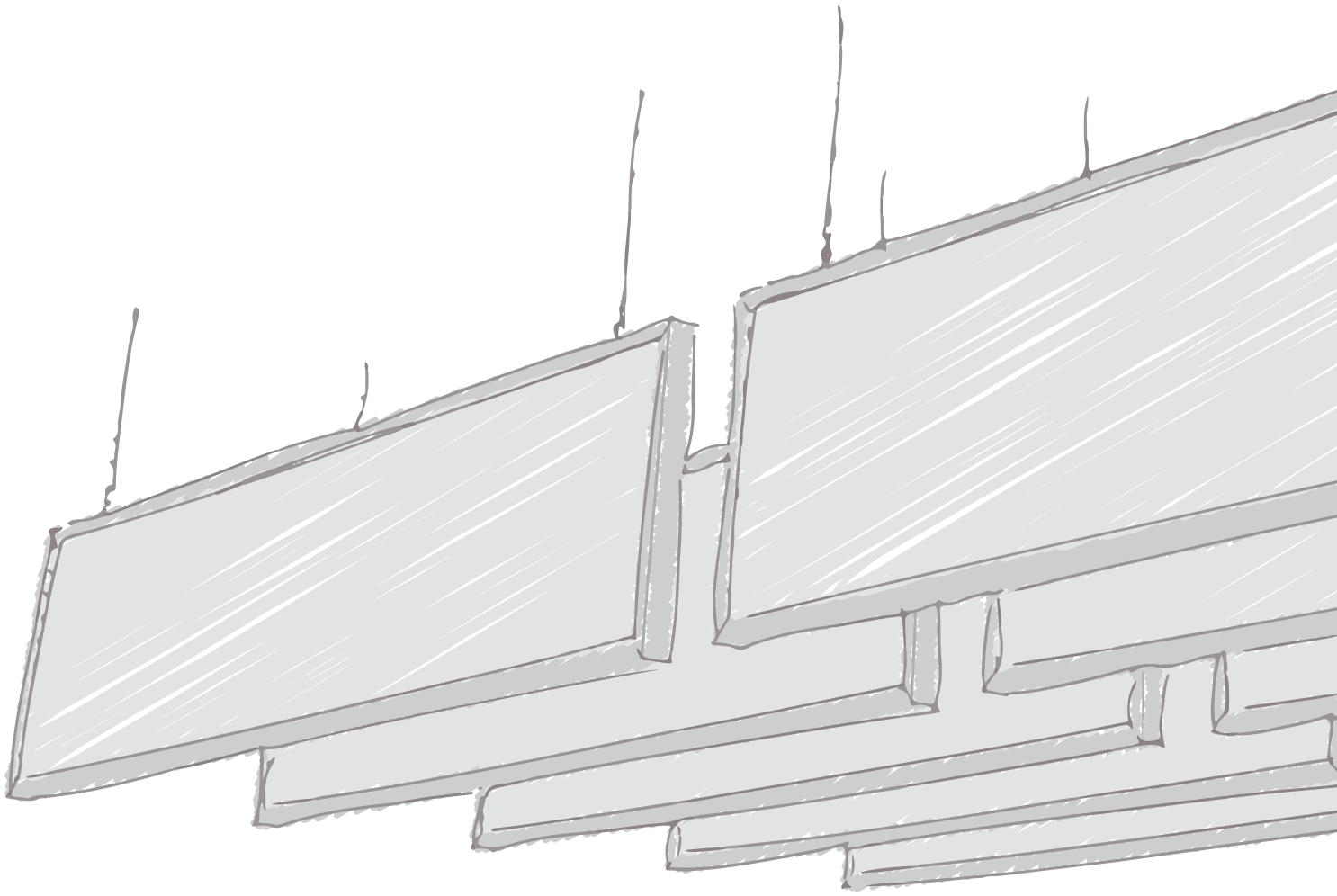

BAFFLE
BAFFLE BASIC

Item specifications

Sound-absorbing element, CELENIT model ACOUSTIC BAFFLE BASIC ..., vertically suspended, composed of two CELENIT wood wool panels, assembled and held together by a post-painted galvanized steel frame - dim. 1200 x 300 x 30 mm. Material properties: thermal and acoustic insulation, eco-friendly and sound absorbing boards - CELENIT ... product range, CELENIT ... item No. ... - made of mineralized ... fir wood wool bound with white Portland cement, it complies with EN 13168 and EN 13964 standards; dim. 1200 x 300 mm; th. 15 mm; texture ...; straight edges; weight: ... kg/m²; λ_D : ... W/mK; R_D : ... m²K/W; compressive stress σ_{10} : \geq ... kPa; water vapour transmission μ : 5; reaction to fire: Euroclass B-s1, d0 or A2-s1, d0 (EN 13501-1 standard); sound absorption: α_w ... / NRC ...;

durability: class C; light reflection: 50.7 o 74.0% (painted white 05/15); release of formaldehyde: class E1; it does not contain asbestos. Wood wool boards must be certified by ANAB-ICEA and natureplus for eco-compatibility of materials and manufacturing process, PEFC™ or FSC® for the sustainability of wood raw material, ICEA for the content of recycled material and for the attestation of LEED credits, EPD for the environmental statement.

Texture



Extra-thin texture 1 mm
CELENIT ABE - CELENIT ABE/A2



Thin texture 2 mm
CELENIT AB - CELENIT AB/A2

Colors

CELENIT BAFFLE offers the possibility of also personalizing the choice of panel and frame colors - a wide range of standard CELENIT colors are available, as well as the various color systems, such as RAL and NCS.



Nature

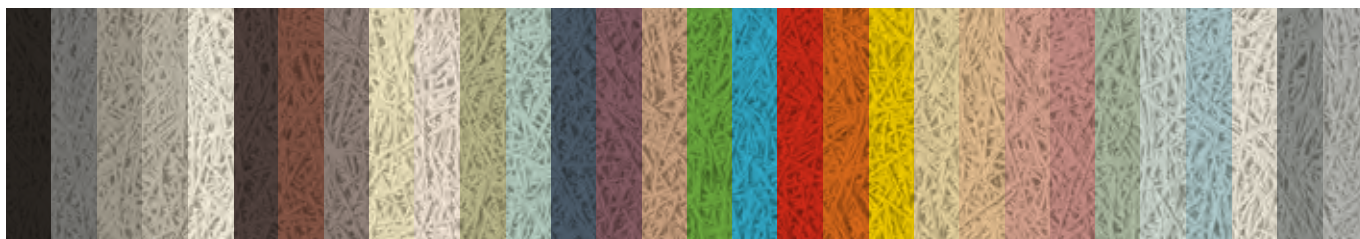

Colors

The colour chart "Colors" (page 98) is available in the download area of the website www.celenit.com. Please ask for a sample at techsupport@celenit.com for a true reference of the shade.

Composition

CELENIT BAFFLE consists of two CELENIT wood wool panels, thickness 15 mm, assembled and held together by a post-painted galvanized steel 10/10 mm frame, anchored to the suspension system with two threaded inserts.

Technical features of the element				
Size	Nominal dimensions [mm]	Overall dimensions [mm]	Weight [kg/pcs]	
			CELENIT AB CELENIT ABE	CELENIT AB/A2 CELENIT ABE/A2
L Large	1200x300 thickness 30	1202x302 thickness 32	8.87	10.74

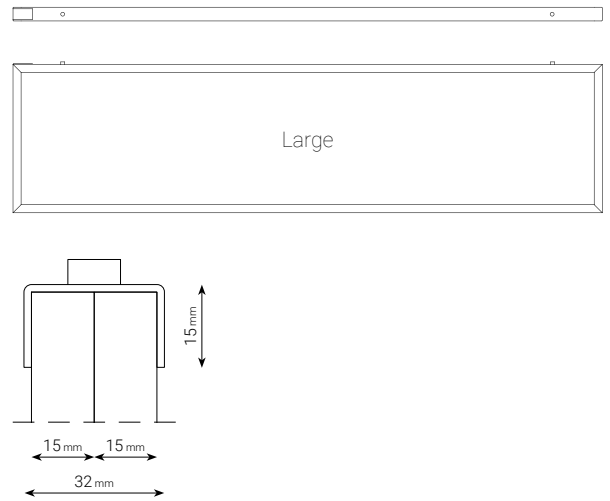

Suspension systems

The suspension system is chosen according to the esthetic effect you want to create. The suspension systems selected are fastened to the two threaded inserts on the upper part of the frame.

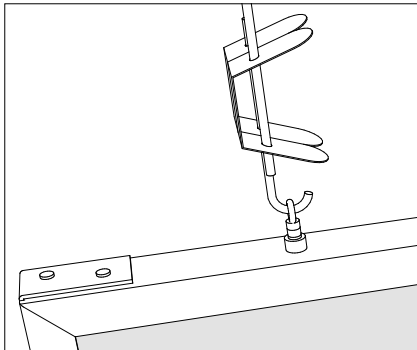

SUSPENSION WITH HANGER

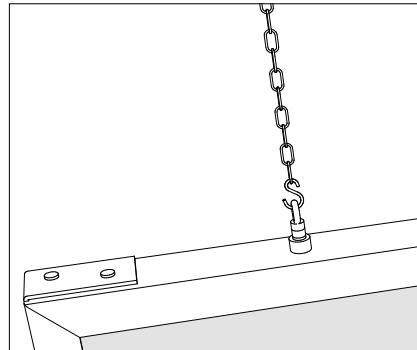

SUSPENSION WITH CHAIN

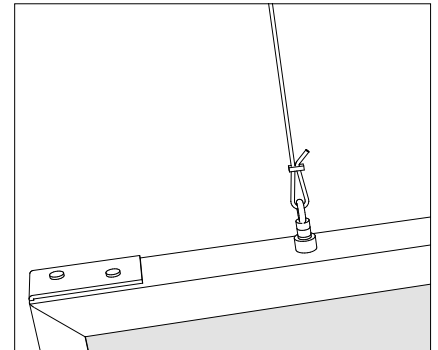

SUSPENSION WITH WIRE

The suspension systems are given here as an example. You will have to verify the suitability of the suspension and anchoring system chosen based on the weight of the elements and the type of horizontal support. CELENIT S.p.A. does not assume responsibility for the choice of the type of suspension and anchoring to use.

Storage, use and maintenance

The boards must be stored on a pallet placed on a flat surface, protected from rain and direct sunlight. Pallets must be handled with care on site. Bumping the corners of the pallets can cause damage to the boards. For more information see the "Storage, use and maintenance" information (page 108) available in the download area of the website www.celenit.com.

CELENIT boards are dimensionally stable (EN 13168), however, they must be installed after acclimating to the same room they are going to be installed in, as well as after all concrete works are finished and the doors, windows, heating and ventilation systems have been installed.

Room temperature must be kept constant before and after installation. Do not suddenly change the temperature of the room after installation.



General installation instructions

BAFFLE BASIC is delivered in two separate packages: wood wool boards on pallets; metallic frames on packagings. The element assembly will be done on site.

Pay particular attention when handling the panels in the installation site, above all if painted. Clean equipment and gloves are required to carry out all work on the panels; therefore, carefully follow the instructions on handling the panels by consulting the sheet "Storage, use and maintenance" (page 108) available on the website www.celenit.com.

The boards have one side that should be visible (**front of the board**) and another side that should be placed against the structure (**back of the board**). The back of the board usually has CELENIT logo or shows marks of calibration. The front may be painted and/or has edges' works. In the absence of paint or edges it is possible to identify the front according to the pallet's layout: the front of the boards is towards the top and the back down towards the pallet.

Upon completing frame assembly, carry out all the final post-installation operations, described on the sheet "Storage, use and maintenance".

BAFFLE BASIC assembly

- BAFFLE BASIC is assembled with the **two panel fronts facing outward**. Insert both panels inside the structure at the same time, slightly opening the two ends of the frame and sliding the bottom part of the panels inside the lower part of the frame.
- Lower the frame and bring it close to the perimeter of the panels, then close the two ends with appropriate **rivets** in the holes on the bracket. The closing bracket will be facing the external part of the frame but will not be visible as it is located in the upper part of the baffle.
- Use a Ø 6 threaded steel eye bolt for hooking the suspension system.
- Fasten the selected suspension system to the ceiling with suitable fixing systems, sized according to the weight of the baffle.

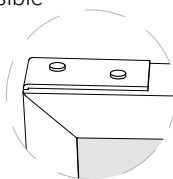



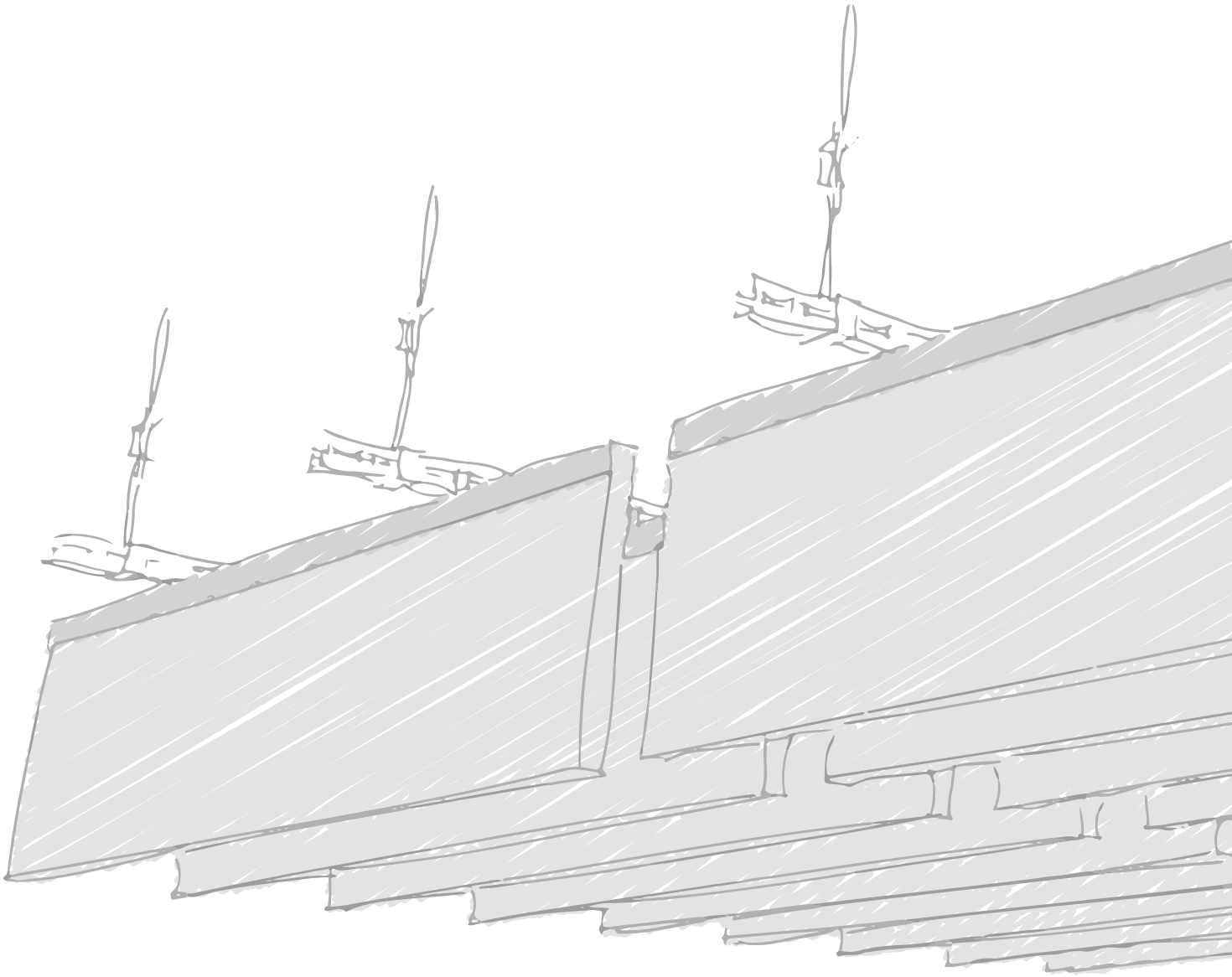

BAFFLE
BAFFLE SMART

Item specifications

Sound-absorbing element, CELENIT model ACOUSTIC BAFFLE SMART ..., vertically suspended, composed of one no painted CELENIT wood wool panel, fixed with screw to a post-painted galvanized steel profile - dim. 1200 x ... x 25 mm. Material properties: thermal and acoustic insulation, eco-friendly and sound absorbing boards - CELENIT ... product range, CELENIT ... item No. ... - made of mineralized ... fir wood wool bound with white Portland cement, it complies with EN 13168 and EN 13964 standards; dim. 1200 x ... mm; th. 25 mm; texture ...; straight edges; weight: ... kg/m²; λ_D: ... W/mK; R_D: ... m²K/W; compressive stress σ₁₀: ≥ ... kPa; water vapour transmission μ: 5; reaction to fire: Euroclass B-s1, d0 or A2-s1, d0 (EN 13501-1 standard); sound absorption: α_w ... / NRC ...;

durability: class C; light reflection: 50.7 o 74.0% (painted white 05/15); release of formaldehyde: class E1; it does not contain asbestos. Wood wool boards must be certified by ANAB-ICEA and natureplus for eco-compatibility of materials and manufacturing process, PEFC™ or FSC® for the sustainability of wood raw material, ICEA for the content of recycled material and for the attestation of LEED credits, EPD for the environmental statement.

Texture



Extra-thin texture 1 mm
CELENIT ABE - CELENIT ABE/A2



Thin texture 2 mm
CELENIT AB - CELENIT AB/A2

The boards are supplied in natural version without paint. The boards can be painted on site with an airless spraying device. For more information about the painting on site see the colour chart “Colors” (page 98) available in the download area of the website www.celenit.com.

Composition

BAFFLE SMART consists of one **no painted** CELENIT wood wool panel, thickness 25 mm, fixed with screw to a post-painted galvanized steel 10/10 mm profile, anchored to the suspension system with two perforated brackets. Available in three sizes.

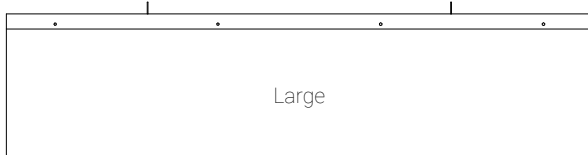
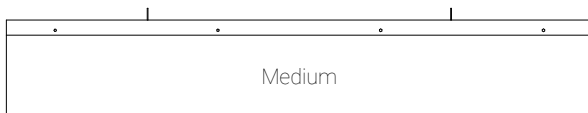

Technical features of the element				
Size	Nominal dimensions [mm]	Overall dimensions [mm]	Weight [kg/pcs]	
			CELENIT AB CELENIT ABE	CELENIT AB/A2 CELENIT ABE/A2
S Small	1200x150 thickness 25	1200x151 thickness 25	3.01	3.82
M Medium	1200x200 thickness 25	1200x201 thickness 25	3.70	4.78
L Large	1200x300 thickness 25	1200x301 thickness 25	5.08	6.70

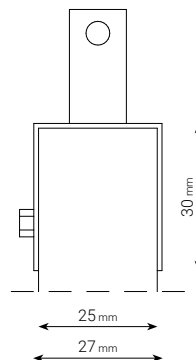

Suspension systems

Modular mounting kit

BAFFLE SMART mounting kit allows you to fasten the elements quickly and easily. The U-profile holes allow you to install BAFFLE SMART with a minimum spacing of 50 mm or multiples of 50 mm.

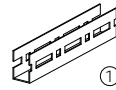
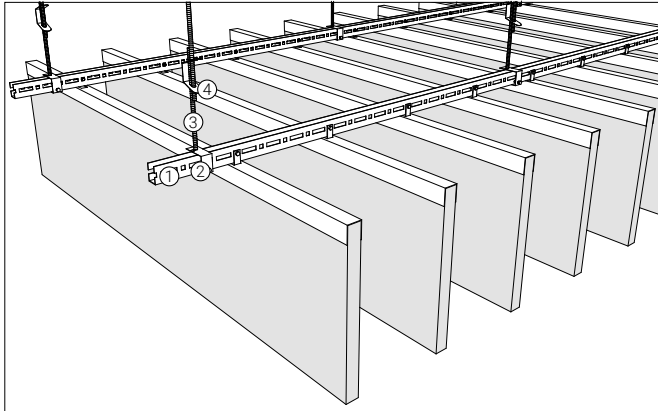

Galvanized steel and post-painted U-profile
Dimensions 20x30 mm, length 4000 mm
Thickness 15/10
Spacing between profiles 600 mm

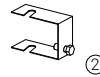

Galvanized steel and post-painted U-bracket
for fixings of the threaded bar



Threaded bar
Ø 6 mm



Spring for threaded bar connection

Baffles suspended individually

As an alternative of modular mounting kit, the designer can choose to install the baffles individually. The suspension systems selected are fastened to the two perforated brackets on the upper part of the frame.

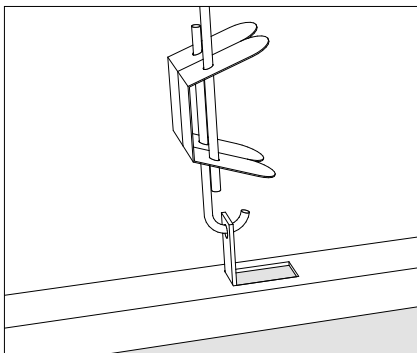

SUSPENSION WITH HANGER

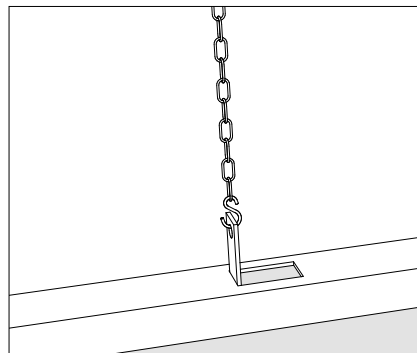

SUSPENSION WITH CHAIN

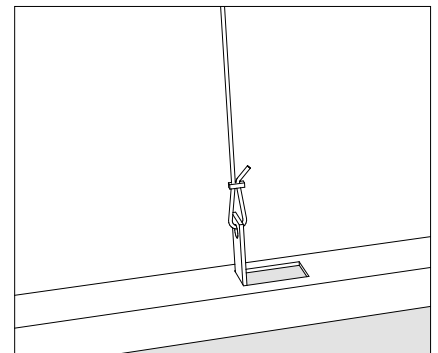

SUSPENSION WITH WIRE

The suspension systems are given here as an example. You will have to verify the suitability of the suspension and anchoring system chosen based on the weight of the elements and the type of horizontal support. CELENIT S.p.A. does not assume responsibility for the choice of the type of suspension and anchoring to use.

Storage, use and maintenance

The boards must be stored on a pallet placed on a flat surface, protected from rain and direct sunlight. Pallets must be handled with care on site. Bumping the corners of the pallets can cause damage to the boards. For more information see the "Storage, use and maintenance" information (page 108) available in the download area of the website www.celenit.com.



CELENIT boards are dimensionally stable (EN 13168), however, they must be installed after acclimating to the same room they are going to be installed in, as well as after all concrete works are finished and the doors, windows, heating and ventilation systems have been installed.

Room temperature must be kept constant before and after installation. Do not suddenly change the temperature of the room after installation.

General installation instructions

BAFFLE SMART is delivered in two separate packages: wood wool boards on pallets; metallic frames on packagings. The element assembly will be done on site.

The boards have one side that should be visible (**front of the board**) and another side that should be placed against the structure (**back of the board**). The back of the board usually has the CELENIT logo or shows calibration marks. The front may be painted and/or has worked edges. In the absence of paint or edges, the front can be identified according to the pallet layout: the front of the boards faces the top and the back faces the pallet.

BAFFLE SMART assembly

- Insert the frame on the panel. Drill the panel with a drill where the holes of the structure are located.
- Fix the frame to the panel with 4 threaded screws and locking nuts.

Mounting kit

- The fixing scheme must be chosen according to the spacing between baffles. Fix the threaded bars to the ceiling with suitable anchors, sized according to the weight of the baffle.
- Install the support structure: U-profile every 600 mm, U-bracket and threaded bars connected with springs for threaded bars (see page 93).
- Fix BAFFLE SMART to U-profile with two screws and locking nuts according to the fixing scheme chosen.

The U-profile holes allow you to install BAFFLE SMART with a minimum spacing of 50 mm or multiples of 50 mm. Carefully design the fixing scheme of the anchors suitable to bear the overall weight of the system.

Alternatives suspension systems

- Fix the suspension elements to the ceiling with suitable anchors, sized according to the weight of the baffle.
- Hook the suspension systems to the two perforated brackets on the upper part of the frame.

Pay particular attention when handling the panels in the installation site, above all if painted. Clean equipment and gloves are required to carry out all work on the panels; therefore, carefully follow the instructions on handling the panels by consulting the sheet "Storage, use and maintenance" (page 108) available on the website www.celenit.com.

Upon completing frame assembly, carry out all the final post-installation operations, described on the sheet "Storage, use and maintenance".



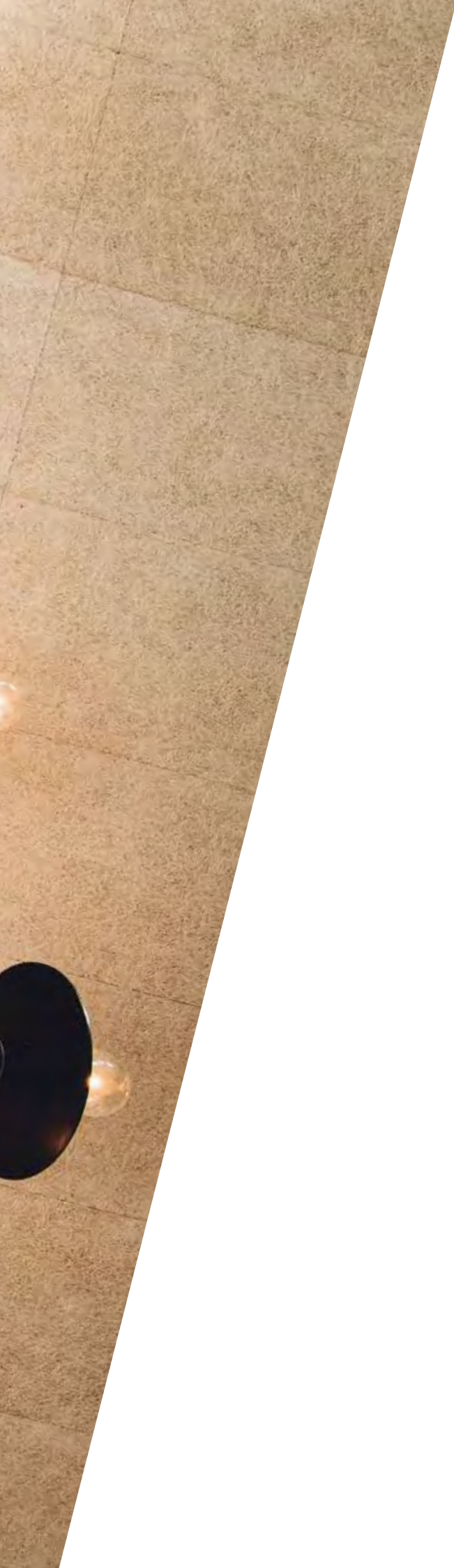

TECHNICAL SPECIFICATIONS

Colors

Sustainability

Sound absorption

Impact resistance

Fire resistance

Storage, use and maintenance

COLORS

Colors

NATURE Natural panel without painting.



Extra-thin texture - ABE
1 mm



Thin texture - AB
2 mm



Standard texture - NB
3 mm

WINTER



Black
Code S08/14



Slate
Code S11/16



Ash grey
Code S07/16



Pearl grey
Code S08/16



White
Code S05/15

AUTUMN



Moka
Code S14/14



Brown
Code S11/14

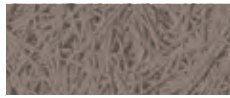

Tobacco
Code S17/15



Cream
Code 13/15



Light ochre
Code S08/15



Pistachio green
Code S25/16

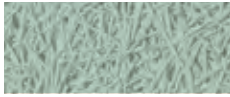

Turquoise
Code S19/15



Night blue
Code S20/16



Plum
Code S16/16



Antique pink
Code S20/15

SUMMER



Green
Code S02/14



Azure
Code S01/15



Red
Code S13/14



Orange
Code S04/14



Yellow
Code S06/14

SPRING



Honey
Code B30017



Siena
Code B30016

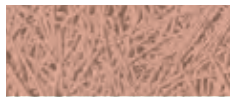

Pink
Code B30015



Pink powder
Code B30014



Sage
Code B30011



Sky blue
Code B30009



Aquamarine
Code B30008



Gardenia
Code B30093



Light grey
Code B30007



Grey
Code B30006



The brand natureplus refers to SPRING colors range

RAL or NCS colors are available on request, after sampling: the finish may have slight differences compared to the colors of the reference table. The colors reproduced here, although close to the real ones, are purely indicative.

On request special colors specific for applications in place with high relative humidity. For any request or samples contact the technical office: techsupport@celenit.com.

Types and application methods

COLOR CHOICE

The right choice of colors is essential for a good esthetic result. CELENIT Boards can be natural or painted. Natural panels may present an uneven texture and color due to the natural raw materials and production process. This characteristic is more evident for grey Portland cement panels. The color tends to be more homogeneous over time. If a homogeneous color is required, the boards must be painted.

CELENIT acoustic panels are painted with standard acrylic highly breathable colors, which are listed in our catalogue. On request CELENIT also provides panels painted with washable "eco" paint, with liquid silicate potassium compound binders and inorganic pigments derived from natural products, absolutely free of solvents or substances harmful to health.

In addition to the CELENIT standard color range, it is possible to choose from the majority of RAL or NCS references, bearing in mind that the panels background will affect the painting result.

Therefore, to have a real idea of the final effect of the color on the panels, it is advisable to ask the technical office for samples.

PAINTING THE PANELS

The panels can be painted on the factory line or on site.

Boards painted in the factory

For boards painted on the factory line, a small tin of paint is provided upon request for all necessary touchups.

Boards painted on site

For natural boards painted on site, make sure they are well cleaned, and free of dust or dirt. Make sure to use appropriate personal protective equipment.

Before proceeding with painting, it is advisable to dilute (approximately with 30% of water) the paint to avoid to block the cavities of the panels with a viscous paint.

Apply the paint in both directions with an airless spraying device at a 45° angle. Spray the paint evenly on the entire surface and do not use too much in order to avoid blocking the panel cavities.

Apply max 400-500 g/m². If a second coat of paint is needed, make sure the first coat is completely dry.

PAINTING TIPS

For a good esthetic result, it is advisable to use clean gloves, to keep the work tools clean (especially the support bench and cutting tools) and to eliminate dust and/or impurities from the panels.

After installation, the panels must be touched up with the paint provided in order to cover the screws and accidental scratches. A traditional brush, paint roller/brush or airless spray device can be used.

For more information see the "Storage, use and maintenance" information (page 108) available in the download area of the website www.celenit.com.

Always consult the CELENIT safety data sheet (available at www.celenit.com) and the safety data sheet for the paint to ensure the safety of operators during application.

Sustainability

Sustainability is a core issue in CELENIT’s mission: producing an eco-friendly certified insulator from natural raw materials.

Certifications of raw materials and products guarantee their reliability and the respect for the environment. As an incentive to build responsibly, they become a useful tool for designers to work in conformity with the sustainability protocols standards. CELENIT products can contribute to obtaining LEED (The Leadership in Energy and Environmental Design) credits,

in order to achieve and communicate a wider perspective of sustainability and eco-construction.



Environmental Product Declaration which quantifies the environmental performance of a product through appropriate categories of parameters calculated using the Life Cycle Assessment (LCA) method and following the ISO 14040 standard.



The mark of responsible forestry
FSC® C122980

The Association promotes the conservation and the improvement of forest resources all over the world, through the economically sustainable and socially helpful management of the forest, in harmony with the international mission of the Forest Stewardship Council®, FSC®. In our manufacturing process, all wood wool boards can be made with FSC® certified wood.



PEFC is one of the main organizations of forestry certifications in the world, and it is an international non-profit, non-governmental organization, dedicated to promoting sustainable forest management. CELENIT complies with all PEFC standards for the production of its wood wool panels. All the wood wool panels are manufactured in our production process with PEFC™ certified wood.



The international association natureplus for Future-Oriented Building and Accommodation, has the mission of promoting products for sustainable construction and interior design, by assigning a mark of quality that meets the sustainability targets for the economic and social sectors the natureplus logo identifies suitable products for sustainable building. In this certificate, all CELENIT products that are natureplus certified are indicated



ANAB (National Association of Bio-ecological Architecture) is the most important Italian association in the field of sustainable buildings and it involves professionals and operators throughout Italy. The ANAB – CERTIFIED PRODUCT FOR GREEN BUILDING logo identifies monolayer products made by wood wool with a limited environmental impact. CELENIT wood wool panels comply with building material requirements of the most important certification and building evaluation systems and provide a guarantee of the respect for human health and of the safety of end-users and workers.



The Ethical and Environmental Certification Institute (ICEA), recognizing the core importance of materials recycling for the growth of a sustainable production and consumption model, developed the “Standards for the certification of products made from recycled materials”. In this certificate, wood wool products are divided according to the percentages of recycled content. ICEA also evaluates the environmental profile through the LCA analysis and attests that CELENIT products meet the requirements of the LEED protocol credits.

Sound absorption

CELENIT boards were tested in reverberation room reproducing the three most common installations: application in adherence, empty air-gap, background filling, Baffle

Thanks to a broad range of tests and research, CELENIT has implemented the exposed covering systems and provides documentation indicating the sound absorption values for the three categories of products: wood wool boards (CELENIT ACOUSTIC and CELENIT ACOUSTIC A2 ranges, CELENIT BAFFLE SMART), composite wood wool boards with rock wool (CELENIT ACOUSTIC MINERAL and CELENIT MINERAL A2 ranges) and composite wood wool boards with fire resistant plasterboard (CELENIT ACOUSTIC FIRE).

With the ACOUSTIC | DESIGN products line, CELENIT provides advanced solutions that blend high sound absorption performance with the sustainability and eco-compatibility of a natural product, which is also aesthetically attractive and mechanically resistant.

Application in adherence

The application is divided into three types depending on the type of the board selected for the acoustic correction:

- panels fixed to the structural support (floor/wall)
- panels screwed to the support
- application with "permanent formwork" system

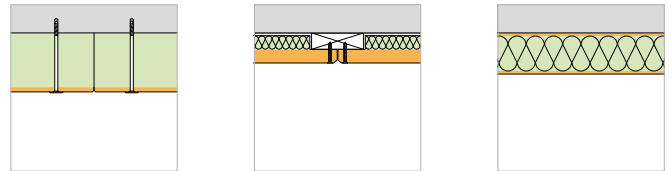

Empty air gap

The panels can be installed on a metal or wooden structure which can be hidden by the sound-absorption covering. It is thus to create an air gap which improves the sound absorption performance of the system.

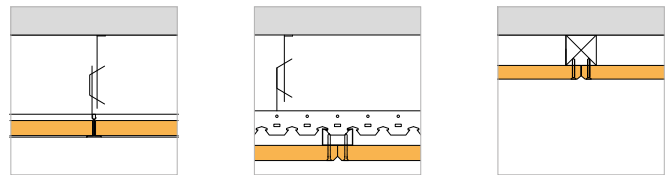

Background filling

Placing a soft insulation panel made of wood fiber or rock wool you can improve the performance of the acoustic covering, especially at mid-low frequencies.

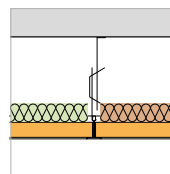

Baffle

Sound-absorbent modules, which, when placed vertically to the ceiling, permit creating convenient, fast and design solutions without altering the esthetics of the existing ceiling and avoid affecting pre-existing systems.

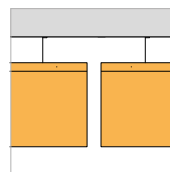

SOUND ABSORPTION

Application in adherence

Type of board ¹	Test specifications ²			Certificate ³		Sound absorption									
	Thickness [mm]	MW [mm]	TH [mm]	No.	Date	Frequencies α_p [Hz]						α_w	NRC	SAA	Class
						125	250	500	1000	2000	4000				
CELENIT ACOUSTIC products range															
CELENIT AB	15		15	324212-A	30.04.2015	0.05	0.10	0.20	0.35	0.75	0.60	0.30 (H)	0.35	0.35	D
CELENIT AB	25		25	331332-A	11.02.2016	0.10	0.20	0.40	0.85	0.80	0.85	0.45 (M-H)	0.55	0.56	D
CELENIT AB	35		35	333105-A	20.04.2016	0.15	0.25	0.50	0.95	0.70	0.85	0.50 (M-H)	0.60	0.60	D
CELENIT AB	50		50	324219-A	30.04.2015	0.15	0.30	0.65	0.95	0.70	0.85	0.60 (M-H)	0.65	0.64	C
CELENIT ABE	15		15	324526-A	14.05.2015	0.05	0.10	0.25	0.45	0.80	0.65	0.30 (H)	0.40	0.40	D
CELENIT ABE	25		25	331334-A	11.02.2016	0.10	0.20	0.35	0.70	0.85	0.85	0.40 (M-H)	0.55	0.53	D
CELENIT ABE	35		35	331335-A	11.02.2016	0.10	0.25	0.45	0.85	0.70	0.95	0.50 (M-H)	0.55	0.56	D
CELENIT ACOUSTIC A2 products range															
CELENIT AB/A2	25		25	331333-A	11.02.2016	0.10	0.20	0.40	0.80	0.80	0.85	0.45 (M-H)	0.55	0.55	D
CELENIT ABE/A2	25		25	324524-A	14.05.2015	0.10	0.15	0.25	0.45	0.75	0.60	0.35 (H)	0.40	0.39	D
CELENIT ACOUSTIC MINERAL products range															
CELENIT L2AB25	50		55	326376-A	20.07.2015	0.15	0.40	1.00	0.90	0.75	0.90	0.70 (M-H)	0.80	0.77	C
CELENIT L2ABE25	43		47	326172-A	14.07.2015	0.15	0.35	0.85	1.00	0.85	0.90	0.65 (M-H)	0.75	0.77	C
CELENIT L2ABE25	50		55	326172-B	14.07.2015	0.25	0.65	1.00	1.00	0.90	0.90	0.90	0.90	0.90	A
CELENIT L2ABE25	65		70	326172-C	14.07.2015	0.30	0.75	1.00	0.95	0.90	0.90	0.95	0.95	0.93	A
CELENIT L2ABE35	75		80	331339-A	11.02.2016	0.30	0.90	1.00	1.00	0.95	1.00	1.00	1.00	0.99	A
CELENIT L2ABE25C	50		50	331337-A	11.02.2016	0.20	0.55	1.00	1.00	0.95	1.00	0.85 (H)	0.90	0.87	B
CELENIT L2ABE25C	75		75	326379-B	20.07.2015	0.35	0.90	1.00	1.00	0.90	0.90	1.00	1.00	0.98	A
CELENIT L2ABE25C	100		100	326379-C	20.07.2015	0.45	1.00	1.00	1.00	0.90	0.90	1.00	1.00	0.99	A
CELENIT MINERAL A2 products range															
CELENIT L2AB/A2	50		50	326374-A	20.07.2015	0.25	0.70	1.00	1.00	0.95	0.90	0.95	0.95	0.93	A
CELENIT L2AB/A2	75		75	333108-A	20.04.2016	0.45	1.00	1.00	1.00	0.95	0.75	0.95 (L)	1.05	1.03	A
CELENIT L2AB/A2	100		100	326374-C	20.07.2015	0.55	0.85	0.95	0.95	0.95	0.90	0.95	0.90	0.92	A
CELENIT L2AB/A2	125		125	333108-C	20.04.2016	0.70	1.00	1.00	1.00	0.90	0.80	0.95 (L)	1.00	1.01	A
CELENIT L2ABE/A2	50		50	326377-A	20.07.2015	0.30	0.75	0.95	0.90	0.85	0.80	0.90	0.85	0.85	A
CELENIT L2ABE/A2	75		75	333109-A	20.04.2016	0.45	1.00	1.00	1.00	1.00	0.85	1.00	1.05	1.05	A
CELENIT L2ABE/A2	100		100	333109-B	20.04.2016	0.55	1.00	1.00	1.00	0.95	0.85	1.00	1.05	1.03	A
CELENIT L2ABE/A2	125		125	333109-C	20.04.2016	0.65	1.00	1.00	1.00	0.95	0.85	1.00	1.05	1.03	A
CELENIT L3AB/A2	50		50	324536-A	14.05.2015	0.25	0.65	1.00	1.00	1.00	0.90	0.95	0.95	0.95	A
CELENIT L3AB/A2	75		75	324537-A	14.05.2015	0.40	0.90	1.00	1.00	1.00	0.90	1.00	1.00	1.00	A
CELENIT L3AB/A2	100		100	333110-A	20.04.2016	0.60	1.00	1.00	1.00	0.95	0.85	1.00	1.00	1.01	A
CELENIT L3AB/A2	125		125	333110-B	20.04.2016	0.65	1.00	1.00	1.00	0.95	0.85	1.00	1.05	1.03	A

Empty air gap

Type of board ¹	Test specifications ²			Certificate ³		Sound absorption									
	Thickness [mm]	MW [mm]	TH [mm]	No.	Date	Frequencies α_p [Hz]					α_w	NRC	SAA	Class	
						125	250	500	1000	2000	4000				
CELENIT ACOUSTIC products range															
CELENIT AB	15		45	324213-A	30.04.2015	0.10	0.15	0.40	0.75	0.45	0.55	0.40 (M-H)	0.45	0.43	D
CELENIT AB	15		115	324213-B	30.04.2015	0.15	0.40	0.65	0.45	0.45	0.70	0.50 (H)	0.50	0.48	D
CELENIT AB	15		215	324213-E	30.04.2015	0.25	0.55	0.50	0.40	0.50	0.70	0.50 (L-H)	0.50	0.49	D
CELENIT AB	25		55	333104-A	20.04.2016	0.10	0.15	0.45	0.65	0.50	0.65	0.45 (H)	0.45	0.44	D
CELENIT AB	25		125	331332-B	11.02.2016	0.25	0.75	0.65	0.50	0.85	0.90	0.60 (L-H)	0.70	0.70	C
CELENIT AB	25		200	331332-C	11.02.2016	0.35	0.75	0.55	0.55	0.80	0.90	0.60 (L-H)	0.65	0.67	C
CELENIT AB	25		225	331332-D	11.02.2016	0.25	0.65	0.60	0.65	0.85	1.00	0.65 (H)	0.70	0.69	C
CELENIT AB	25		425	331332-E	11.02.2016	0.45	0.55	0.50	0.65	0.80	1.00	0.60 (H)	0.60	0.62	C
CELENIT AB	35		135	333105-B	20.04.2016	0.20	0.60	0.70	0.50	0.80	0.80	0.60 (H)	0.65	0.64	C
CELENIT AB	35		300	324217-D	30.04.2015	0.40	0.55	0.45	0.55	0.80	0.80	0.55 (H)	0.60	0.59	D
CELENIT AB	35		435	333105-C	20.04.2016	0.45	0.55	0.50	0.65	0.85	0.90	0.60 (H)	0.65	0.64	C
CELENIT ABE	15		45	324527-A	14.05.2015	0.10	0.15	0.45	0.80	0.55	0.60	0.45 (M-H)	0.50	0.49	D
CELENIT ABE	15		215	324527-B	14.05.2015	0.25	0.55	0.55	0.45	0.60	0.70	0.55 (H)	0.55	0.54	D
CELENIT ABE	15		300	324527-C	14.05.2015	0.30	0.55	0.45	0.55	0.60	0.75	0.55 (H)	0.55	0.54	D
CELENIT ABE	25		55	333106-A	20.04.2016	0.10	0.25	0.65	0.80	0.65	0.85	0.55 (M-H)	0.60	0.59	D
CELENIT ABE	25		75	331334-B	11.02.2016	0.15	0.35	0.80	0.75	0.70	0.95	0.65 (H)	0.65	0.64	C
CELENIT ABE	25		125	331334-C	11.02.2016	0.15	0.45	0.75	0.60	0.75	0.95	0.65 (H)	0.65	0.63	C
CELENIT ABE	25		225	331334-F	11.02.2016	0.25	0.65	0.65	0.60	0.80	1.00	0.65 (H)	0.65	0.66	C
CELENIT ABE	25		300	333106-B	20.04.2016	0.35	0.60	0.50	0.60	0.80	0.95	0.60 (H)	0.60	0.62	C
CELENIT ABE	35		65	331335-B	11.02.2016	0.15	0.30	0.75	0.85	0.75	0.95	0.60 (M-H)	0.65	0.67	C
CELENIT ABE	35		85	331335-C	11.02.2016	0.15	0.35	0.75	0.65	0.75	0.95	0.65 (H)	0.65	0.62	C
CELENIT ABE	35		235	331335-D	11.02.2016	0.30	0.70	0.60	0.70	0.90	1.00	0.70 (H)	0.70	0.72	C
CELENIT ABE	35		300	333107-A	20.04.2016	0.40	0.65	0.50	0.65	0.85	0.95	0.60 (L-H)	0.65	0.66	C
CELENIT ACOUSTIC A2 products range															
CELENIT AB/A2	25		65	331333-B	11.02.2016	0.15	0.30	0.70	0.70	0.65	0.95	0.60 (H)	0.60	0.58	C
CELENIT ABE/A2	25		300	331336-A	11.02.2016	0.30	0.60	0.50	0.65	0.80	1.00	0.60 (H)	0.65	0.64	C
CELENIT ACOUSTIC MINERAL products range															
CELENIT L2AB15	55		225	326375-A	20.07.2015	0.45	0.90	1.00	1.00	0.80	0.75	0.85 (L)	0.95	0.93	B
CELENIT L2AB25	50		225	326376-B	20.07.2015	0.40	0.90	0.85	0.95	0.75	0.90	0.85 (L)	0.90	0.88	B
CELENIT L2AB25	65		225	326376-C	20.07.2015	0.40	0.90	0.95	0.90	0.75	0.90	0.85 (L)	0.90	0.88	B
CELENIT L2ABE15	55		225	326378-A	20.07.2015	0.45	0.90	1.00	1.00	0.90	0.80	0.95	0.95	0.95	A
CELENIT L2ABE25	43		200	326172-D	14.07.2015	0.40	0.85	1.00	0.95	0.85	0.90	0.95	0.90	0.92	A
CELENIT L2ABE25	50		225	326172-E	14.07.2015	0.40	0.85	1.00	1.00	0.85	0.90	0.95	0.95	0.93	A
CELENIT L2ABE25	65		200	326172-F	14.07.2015	0.45	0.90	1.00	1.00	0.85	0.90	0.95	0.95	0.94	A
CELENIT L2ABE35	53		200	331338-A	11.02.2016	0.40	0.95	1.00	1.00	0.95	1.00	1.00	0.95	0.97	A
CELENIT L2ABE25C	50		100	331337-B	11.02.2016	0.30	0.90	1.00	1.00	0.95	1.00	1.00	0.95	0.97	A
CELENIT ACOUSTIC FIRE products range															
CELENIT AB/F	40		95	324523-A	14.05.2015	0.20	0.20	0.25	0.45	0.80	0.60	0.35 (H)	0.40	0.42	D
CELENIT AB/F	40		240	324523-B	14.05.2015	0.15	0.20	0.25	0.45	0.80	0.65	0.35 (H)	0.45	0.42	D

SOUND ABSORPTION

Background filling with rock wool

Type of board ¹	Test specifications ²			Certificate ³		Sound absorption									
	Thickness [mm]	MW [mm]	TH [mm]	No.	Date	Frequencies α_p [Hz]						α_w	NRC	SAA	Class
						125	250	500	1000	2000	4000				
CELENIT ACOUSTIC products range															
CELENIT AB	15	30 (1)	45	324212-B	30.04.2015	0.20	0.50	1.00	0.95	0.65	0.75	0.70 (M)	0.80	0.77	C
CELENIT AB	15	30 (1)	115	324213-C	30.04.2015	0.30	0.80	1.00	0.90	0.75	0.75	0.85	0.85	0.86	B
CELENIT AB	15	50 (2)	200	324213-D	30.04.2015	0.45	0.90	0.95	0.95	0.75	0.75	0.85 (L)	0.90	0.89	B
CELENIT AB	15	40 (1)	290	324213-F	30.04.2015	0.50	0.90	0.95	0.95	0.75	0.80	0.85 (L)	0.90	0.88	B
CELENIT AB	25	30 (4)	55	324214-B	30.04.2015	0.20	0.55	1.00	0.90	0.70	0.90	0.75 (M-H)	0.80	0.79	C
CELENIT AB	25	30 (1)	85	324215-B	30.04.2015	0.25	0.70	1.00	0.80	0.75	0.90	0.80	0.80	0.82	B
CELENIT AB	25	60 (1)	125	324215-D	30.04.2015	0.40	0.90	0.95	0.90	0.80	0.90	0.90	0.90	0.88	B
CELENIT AB	25	30 (4)	200	324215-E	30.04.2015	0.40	0.90	0.95	0.90	0.80	0.90	0.90	0.90	0.88	A
CELENIT AB	25	50 (3)	300	324215-F	30.04.2015	0.50	0.90	0.95	0.95	0.85	0.95	0.95	0.90	0.91	A
CELENIT AB	35	30 (4)	65	324216-B	30.04.2015	0.30	0.75	1.00	0.85	0.85	0.95	0.90	0.90	0.89	A
CELENIT AB	35	60 (1)	135	324217-B	30.04.2015	0.50	1.00	0.95	0.85	0.85	0.95	0.90 (L)	0.90	0.92	A
CELENIT AB	35	40 (4)	200	324217-C	30.04.2015	0.50	0.90	0.95	0.95	0.85	0.95	0.95	0.90	0.92	A
CELENIT AB	35	40 (1)	320	324217-E	30.04.2015	0.55	0.90	0.95	0.95	0.90	1.00	0.95	0.90	0.92	A
CELENIT ABE	15	30 (2)	45	324526-B	14.05.2015	0.20	0.60	1.00	1.00	0.80	0.75	0.85	0.90	0.88	B
CELENIT ABE	15	40 (2)	300	324527-D	14.05.2015	0.50	0.85	0.95	1.00	0.85	0.80	0.90	0.90	0.91	A
CELENIT ABE	25	30 (4)	55	324528-B	14.05.2015	0.25	0.70	1.00	0.95	0.85	0.90	0.90	0.90	0.90	B
CELENIT ABE	25	30 (1)	85	324531-B	14.05.2015	0.35	0.85	1.00	0.95	0.85	0.90	0.95	0.95	0.94	A
CELENIT ABE	25	60 (1)	125	324533-A	14.05.2015	0.50	0.95	0.95	0.95	0.85	0.95	0.95	0.95	0.93	A
CELENIT ABE	25	30 (4)	200	324531-D	14.05.2015	0.50	0.85	0.95	1.00	0.90	0.90	0.95	0.95	0.93	A
CELENIT ABE	25	50 (2)	200	331334-E	11.02.2016	0.50	1.00	1.00	1.00	0.95	1.00	1.00	1.00	0.98	A
CELENIT ABE	25	60 (5)	200	331334-D	11.02.2016	0.35	1.00	0.90	0.85	0.85	1.00	0.90 (L)	0.90	0.89	A
CELENIT ABE	25	40 (3)	225	324533-B	14.05.2015	0.50	0.90	0.95	1.00	0.85	0.95	0.95	0.95	0.93	A
CELENIT ABE	25	50 (2)	300	324531-F	14.05.2015	0.55	0.90	1.00	1.00	0.85	0.95	0.95	0.95	0.94	A
CELENIT ABE	35	30 (2)	65	324534-B	14.05.2015	0.25	0.60	1.00	0.90	0.80	0.95	0.85	0.85	0.84	B
CELENIT ABE	35	40 (2)	200	324535-B	14.05.2015	0.50	0.95	1.00	1.00	0.90	1.00	1.00	0.95	0.94	A
CELENIT ABE	35	40 (2)	300	324535-D	14.05.2015	0.55	0.90	1.00	1.00	0.90	1.00	0.95	0.95	0.93	A
CELENIT ACOUSTIC A2 products range															
CELENIT AB/A2	25	40 (2)	65	324220-B	30.04.2015	0.25	0.60	1.00	1.00	0.80	0.85	0.85	0.90	0.88	B
CELENIT AB/A2	25	60 (2)	125	324222-A	30.04.2015	0.35	0.90	1.00	1.00	0.85	0.85	0.95	0.95	0.94	A
CELENIT AB/A2	25	40 (3)	300	324222-B	30.04.2015	0.50	0.90	1.00	1.00	0.90	0.90	1.00	0.95	0.93	A
CELENIT ABE/A2	25	40 (4)	65	324524-B	14.05.2015	0.25	0.65	1.00	0.95	0.80	0.90	0.85	0.90	0.89	B
CELENIT ABE/A2	25	50 (4)	200	324525-A	14.05.2015	0.45	0.95	0.95	1.00	0.85	0.90	0.95	0.95	0.93	A
CELENIT ABE/A2	25	40 (4)	300	324525-B	14.05.2015	0.50	0.90	0.95	1.00	0.85	0.90	0.95	0.95	0.93	A

Background filling with wood fiber

Type of board ¹	Test specifications ²			Certificate ³		Sound absorption									
	Thickness [mm]	MW [mm]	TH [mm]	No.	Date	Frequencies α_p [Hz]						α_w	NRC	SAA	Class
						125	250	500	1000	2000	4000				
CELENIT ACOUSTIC products range															
CELENIT AB	25	40 (2)	65	333104-B	20.04.2016	0.25	0.60	1.00	0.85	0.75	0.95	0.80 (H)	0.80	0.81	B
CELENIT AB	25	60 (2)	200	333104-C	20.04.2016	0.40	0.90	0.85	0.85	0.80	0.95	0.85 (L)	0.85	0.86	B
CELENIT AB	25	40 (2)	300	333104-D	20.04.2016	0.50	0.90	0.85	0.90	0.85	1.00	0.90	0.85	0.87	A

Baffle

Dimensions [mm]	Test specifications ²			Certificate ³		Sound absorption									
	Lowering (R) [mm]	Distance between baffles (D) [mm]	Spacing between baffles (I) [mm]	No.	Date	Frequencies α_p [Hz]						α_w	NRC	SAA	Class
						125	250	500	1000	2000	4000				
CELENIT BAFFLE SMART															
1200x300	0	0	300	353965-A	31.07.2018	0.20	0.25	0.20	0.30	0.45	0.60	0.30 (H)	0.30	0.30	D
1200x300	200	0	300	353965-B	31.07.2018	0.15	0.20	0.25	0.35	0.50	0.65	0.35 (H)	0.35	0.31	D
1200x300	200	300	300	353965-C	31.07.2018	0.15	0.15	0.20	0.30	0.45	0.60	0.30 (H)	0.30	0.26	D
1200x300	200	0	200	353965-D	31.07.2018	0.20	0.20	0.30	0.40	0.60	0.75	0.40 (H)	0.40	0.38	D

Note

¹ Paint doesn't affect sound absorption performances of CELENIT boards as described in the technical note provided by Giordano Institute dated 16.07.2015. Sound absorption values are also valid for products with grey cement.

² Test specifications

- "thickness" is relative to CELENIT board
- "MW" is the thickness of rock wool in the background - "WF" is the thickness of wood fiber CELENIT FL/45
 (1) density 40 kg/m³ (3) density 70 kg/m³ (5) mineral wool with natural binder, density 18 kg/m³
 (2) density 50 kg/m³ (4) density 80 kg/m³
- "TH" is the total construction height from the lower edge of ceiling to lower edge of boards.



- "Lowering (R)" is the distance of the Baffle from the ceiling
- "Distance between baffles (D)" is the distance between the elements
- "Spacing between baffles (I)" is the distance between rows of elements

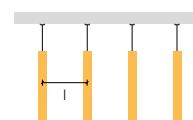
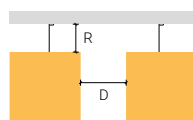





³ All certificate are based on tests carried out at the Giordano Institute (Bellaria - RN - Italy) according to EN ISO 354:2003 standard.

Impact resistance

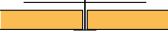
Impact resistance is essential in sports facilities.

CELENIT has certified solutions for false ceilings and wall coverings that are resistant to being hit by balls. This feature is very important to guarantee the stability of covering systems. The resistance of the boards has been tested by Giordano Institute, according to EN 13964 and DIN 18032-3, obtaining the A1 class resistance, which is highest attainable.

	Type of board	Structure	Certificate	Standard	Results
Ceiling					
	CELENIT AB Thickness: 25 mm Dimensions: 1200x600 mm Edges: Chamfered - S4	C metal section 27x60x27 mm Distance between centers of cross joists: 600 mm Distance between centers of main joists: 900 mm Number of screws per board: 9	332601 31.03.2016	EN 13964 DIN 18032-3	Class 1A Pass*
	CELENIT AB Thickness: 35 mm Dimensions: 1200x600 mm Edges: Chamfered - S4	C metal section 27x60x27 mm Distance between centers of cross joists: 600 mm Distance between centers of main joists: 900 mm Number of screws per board: 9	332602 31.03.2016	EN 13964 DIN 18032-3	Class 1A Pass*
	CELENIT AB Thickness: 25 mm Dimensions: 1200x600 mm Edges: Straight - DT	Profilo metallico a "T" 24x38 mm Distance between centers of cross joists: 1200 mm Distance between centers of main joists: 600 mm Anti-lift pin: 2 per board	200535 22.08.2005	EN 13964	Class 1A
	CELENIT ABE Thickness: 25 mm Dimensions: 1200x600 mm Edges: Chamfered - S4	Wood laths section 60x30 mm Distance between centers of cross laths: 600 mm Distance between centers of main laths: 900 mm Number of screws per board: 9	332600 31.03.2016	EN 13964 DIN 18032-3	Class 1A Pass*
Wall					
	CELENIT AB Thickness: 25 mm Dimensions: 1200x600 mm Edges: Chamfered - S4	C metal section 27x60x27 mm Distance between centers of cross joists: 300 mm Distance between centers of main joists: 600 mm Number of screws per board: 9	324044 27.04.2015	DIN 18032-3	Pass*
	CELENIT AB Thickness: 35 mm Dimensions: 1200x600 mm Edges: Chamfered - S4	C metal section 27x60x27 mm Distance between centers of cross joists: 600 mm Distance between centers of main joists: 600 mm Number of screws per board: 9	324043 27.04.2015	DIN 18032-3	Pass*
	CELENIT ABE Thickness: 35 mm Dimensions: 1200x600 mm Edges: Chamfered - S4	Wood laths section 60x30 mm Distance between centers of cross laths: 600 mm Distance between centers of main laths: 600 mm Number of screws per board: 9	324042 27.04.2015	DIN 18032-3	Pass*

* After firing the shots in accordance with clause 7 "Auswertung" of standard DIN 18032-3:1997, the strength, function and safety of the wall elements are not adversely affected and their appearance has not changed.

All certificate are based on tests carried out at the Giordano Institute (Bellaria - RN - Italy).

Fire resistance

Planning that ensures the safety of users in case of fire is crucial.

In crowded public places, fire safety must be designed very carefully in order to avoid risk to people's lives and damage to the goods. Wood wool panels are classified in reaction to fire A2-s1,d0 and B-s1,d0. Furthermore, the fire resistance values of false ceilings can reach 60 minutes of fire resistance (EI60 certificate), maintaining its aesthetic appearance and acoustic qualities.

	Type of board	Structure	Certificate	Standard	Results
False ceiling					
	CELENIT AB/F Thickness: 40 mm Dimensions: 1200x600 mm Edges: Straight - D	C metal section 27x50x27 mm Distance between centers of cross joists: 400 mm Distance between centers of main joists: 600 mm Distance between centers of screws: 300 mm	312748/3620FR 23.01.2014	EN 13501-2:2009	EI 60

All certificate are based on tests carried out at the Giordano Institute (Bellaria - RN - Italy).

Storage, use and maintenance

Instructions for CELENIT sound absorption boards



Protect the pallets from the weather



Always use new gloves or have clean hands

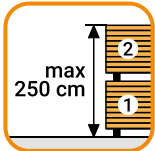

Pallets can be stacked one on top of another, not more, for a maximum height of 250 cm



Do not place the boards on the floor or vertically against the wall



Bumping the corners of the pallets can cause damage to the boards



For more information, contact CELENIT technical department techsupport@celenit.com

PRELIMINARY OPERATION

CELENIT boards are manufactured to ensure the best loading, transport and unloading conditions.

Transport

CELENIT boards are delivered on pallets with a corrugated cardboard protection and secured with plastic strapping. They must travel in covered trucks, safely blocked with security wrappers to avoid any pallet movement during transport that may damage the boards. Pallets are stackable only one on top of another, not more. Maximum care must be taken during loading and unloading operations and when handling the pallets. Use containers for transport by sea or air. After delivery, check if the type and quantity correspond to the transport documents and check the boards for quality problems. Any quality claim must be filed with CELENIT S.p.A. before installing the boards.

Before installation

We recommend not removing the plastic strips and the protection cardboard during pallet storage at the work site. Once the pallet has been opened, we recommend putting a weight on top of it. CELENIT boards must always be moved and stored on their pallets, on a flat surface in dry conditions. Under no circumstances can the boards be stored outdoors, vertically or directly on the floor, or in rooms with a high percentage of humidity.

The corrugated cardboard does not protect from weather, therefore the pallet must remain in a covered and protected place.

Take maximum care when removing the boards from the pallets. The boards must be handled one at a time using both hands. Always have new gloves or clean hands. Damage to the edges or scratches on the paint can easily occur when removing the packaging or accidentally bumping the boards.

Acclimatization

The natural composition of the panels could cause minimal dimensional changes that occur due to sudden changes in the internal environmental conditions, therefore the temperature and relative humidity of the room must remain as constant as possible.

Therefore, it is advisable to mount the panels when the construction work has been completed and after the installation of all equipment and windows.

Leave the panels inside the room for 2 or 3 days, to give them the time to acclimatize to the room conditions. Avoid sudden increases in temperature, just after panel installation.

INSTALLATION

CELENIT boards can be mounted using hidden or visible standard (T and C metal profiles or wooden laths) structures. They can be suspended or in adherence to ceilings or walls. The boards have one side that should be visible (front of the panel) and another side that should be placed against the structure (back of the panel). The back of the board usually has the CELENIT logo or shows marks of calibration. The front may be painted and/or has worked edges.

In the absence of paint or edges, the front can be identified according to the pallet layout: the front of the panels faces the top and the back faces the pallet.

Never invert or mix the panels. Follow the instructions for the chosen installation method.

Mount the boards after having installed all technical systems (air conditioning, heating, illumination) in the ceiling.

Cutting, milling and chamfer the edges

The boards can be easily cut by hand or circular saw. If needed, edges can be chamfered with a medium-grain sand paper. Holes for lighting can be cut by inserting the milling cutter in the front (visible side of the boards).

Always work in clean conditions, especially for the cutting tools. On-site handling on site, cutting, chamfering and milling must be done with great care, cleanliness and professionalism to maintain the esthetic characteristics of the panels. Indications for color touchups are available on the "Colors" sheet (page 98) in the download area of the site www.celenit.com.

AFTER INSTALLATION

Perform all cleaning operations in order to remove any impurities, dust and sediment from inside the porosities of the panels.

Use a vacuum cleaner with a brush to eliminate all dust residue and do all the necessary paint touchups to cover the screws and any scratches.

A tin of paint is provided with the painted boards. When touching up or repainting, be careful not to block panel cavities.

MAINTENANCE

CELENIT panels will maintain their physical and esthetic characteristics over time. They can be periodically cleaned with a vacuum cleaner equipped with a nozzle brush, an electrostatic cloth or a slightly damp cloth.

The user can also choose to repainted installed panels. It is advisable to use water-based acrylic colors and follow the

instructions on the "Colors" sheet (page 98) available in the download area of the site www.celenit.com.

If there are any damaged panels, they can be replaced. Please be aware that due to the natural features of the Boards, there may be some differences in shades if some boards are replaced after a period of time.

NOTE

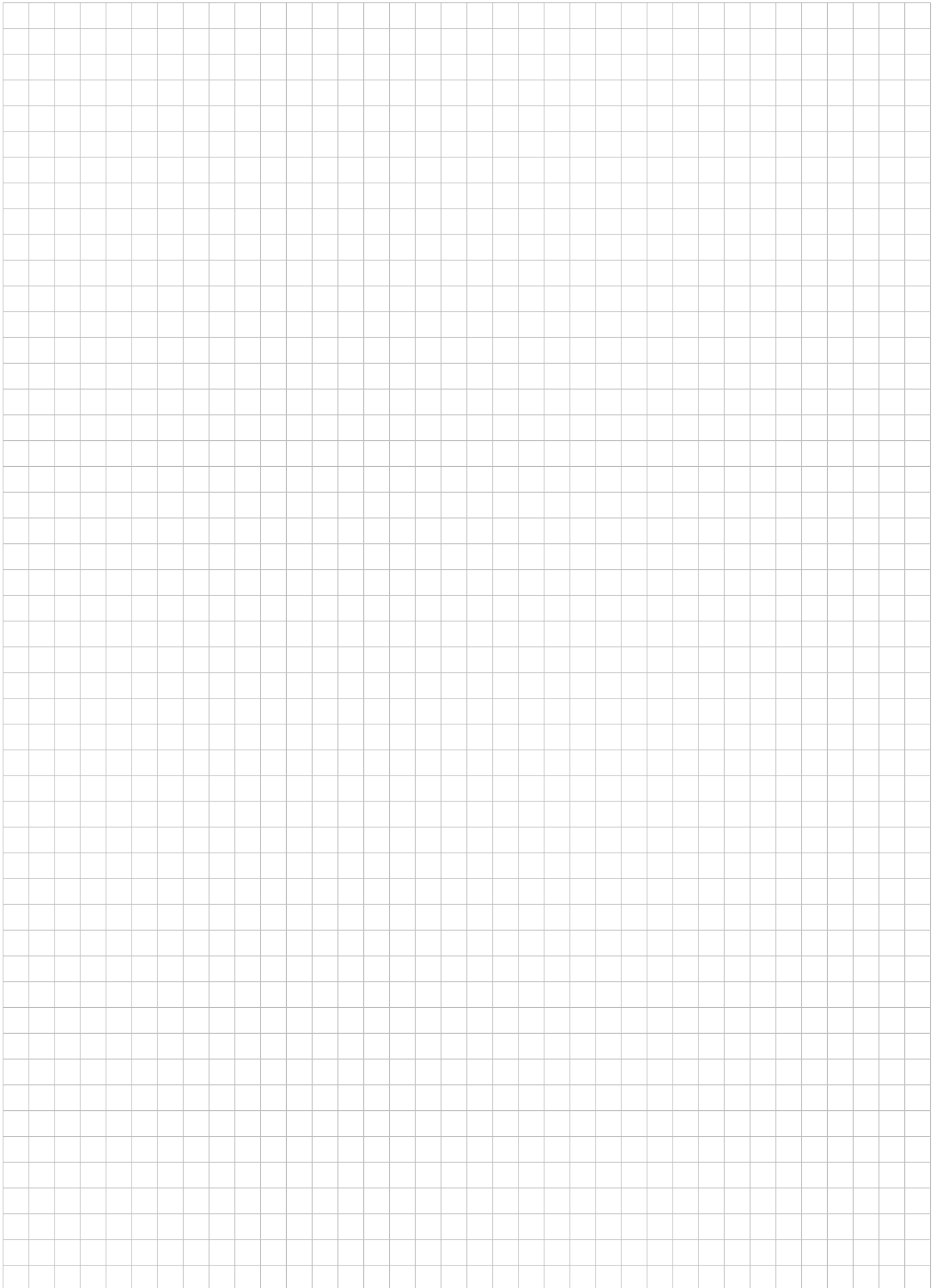

ed. 10/2019

This information is to be considered correct at the time of release. Technical documentation is delivered updated, therefore, when possible, request the most recent version from our technical office.

CELENIT S.p.A. reserves the right to make changes of any nature to improve the product range at any time without prior notice.

